

ylc
metal

Organize Sanayi Bölgesi 18. Cad. No. 24 KAYSERİ / TÜRKİYE
Tel. +90 352 502 87 87
Faks. +90 352 502 87 88
www.ylcmetal.com.tr / info@ylcmetal.com.tr

ylc
metal

2020 Products CITY
FURNITURE



Xenon Shelter

Technical Specifications



Product Dimensions	1755mm X 2732mm X 4735mm
Main Material	Extruded Aluminium Profile
Back Field	8mm Tempered Glass
Roof	12mm Laminated Glass
Ad Visible Area	1705mm X 1155mm
Scroller	Optional- Maximum 3 Ad
Lighting	Flourescent
Coating	Electrostatic Powder Coating (RAL Catalogue)
Galvanize	Iron Materials Hot Dip Galvanized
Guarantee (Outdoor)	2 Year

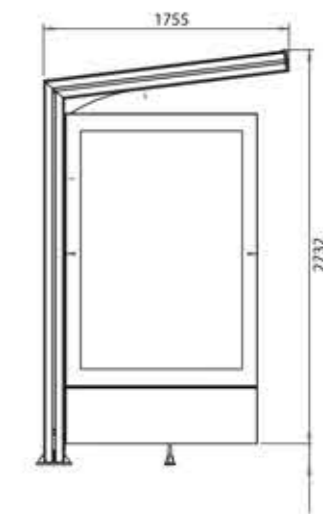
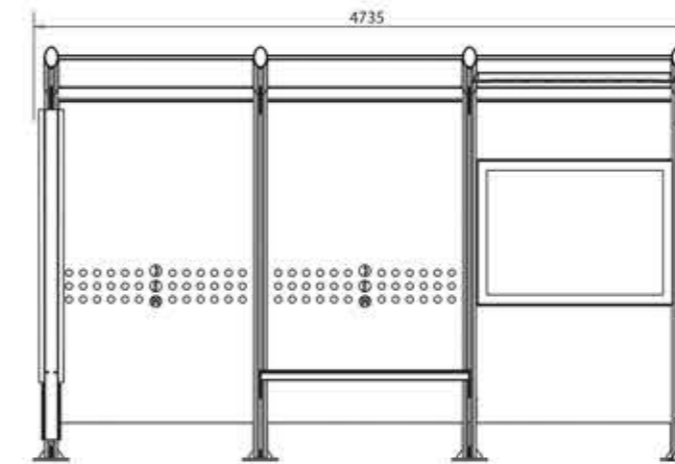

Erciyes 1 Shelter



Technical Specifications

Product Dimensions	1904mm X 2758mm X 4650mm
Main Material	304 Quality Stainless Steel
Back Field	10mm Tempered Glass
Roof	4mm Solid Polycarbonate
Ad Visible Area	1705mm X 1155mm
Scroller	Optional- Maximum 3 Ad
Lighting	Flourescent
Coating	Polisaj
Galvanize	Iron Materials Hot Dip Galvanized
Guarantee (Outdoor)	2 Year

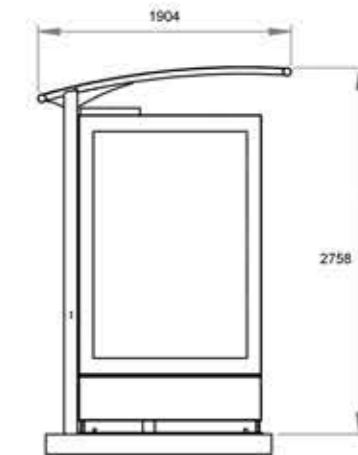
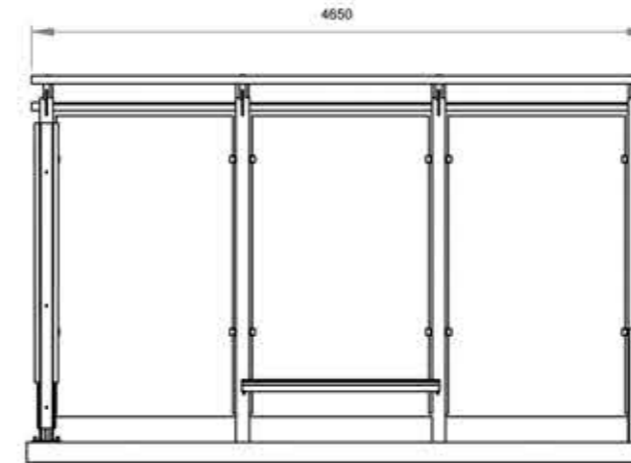

Erciyes 2 Shelter



Technical Specifications

Product Dimensions	1415mm X 2765mm X 4650 mm
Main Material	304 Quality Stainless Steel
Back Field	10mm Tempered Glass
Roof	4mm Solid Polycarbonate
Ad Visible Area	1705mm X 1155mm
Scroller	Optional- Maximum 3 Ad
Lighting	Flourescent
Coating	Polisaj
Galvanize	Iron Materials Hot Dip Galvanized
Guarantee (Outdoor)	2 Year

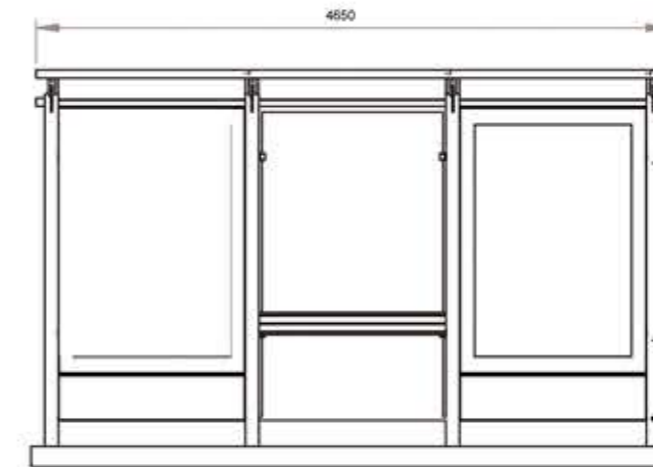

TOD 1006 Shelter

Technical Specifications



Product Dimensions	1620mm X2435 mm X4335 mm
Main Material	Steel Profile
Back Field	10mm Tempered Glass
Roof	8mm Tempered Glass
Ad Visible Area	1705mm X 1155mm
Scroller	Optional- Maximum 3 Ad
Lighting	Flourescent
Coating	Electrostatic Powder Coating (RAL Catalogue)
Galvanize	Iron Materials Hot Dip Galvanized
Guarantee (Outdoor)	2 Year

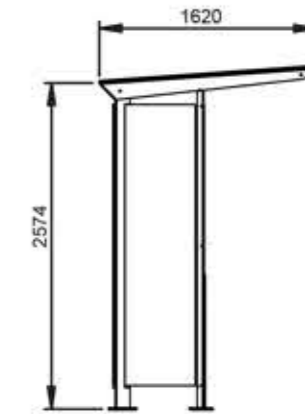
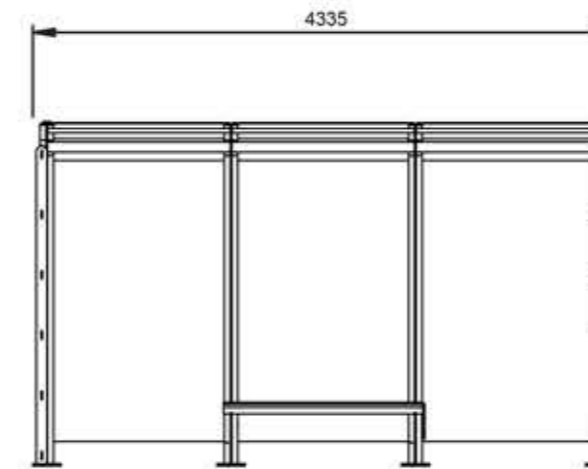

Lifos 1 Shelter



Technical Specifications

Product Dimensions	1998mm X2694mm X6020mm
Main Material	304 Quality Stainless Steel
Back Field	10mm Tempered Glass
Roof	5mm Solid Polycarbonate
Ad Visible Area	1705mm X 1155mm
Scroller	Optional- Maximum 3 Ad
Lighting	Flourescent
Coating	Legs Polisaj, Roof Electrostatic Powder Coating (RAL Catalogue)
Galvanize	Iron Materials Hot Dip Galvanized
Guarantee (Outdoor)	2 Year

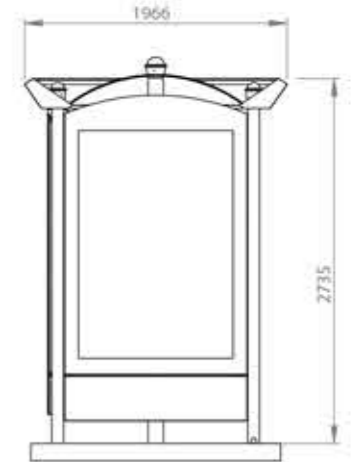
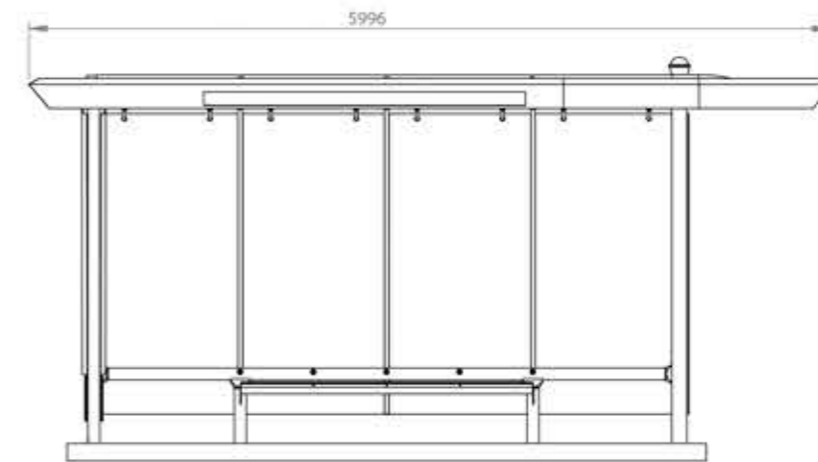

Lifos 2 Shelter

Technical Specifications



Product Dimensions	1937mm X 2937 mm X 5738mm
Main Material	304 Quality Stainless Steel
Back Field	10mm Tempered Glass
Roof	5mm Solid Polycarbonate
Ad Visible Area	1705mm X 1155mm
Scroller	Optional- Maximum 3 Ad
Lighting	Flourescent
Coating	Legs Polisaj, Roof Electrostatic Powder Coating (RAL Catalogue)
Galvanize	Iron Materials Hot Dip Galvanized
Guarantee (Outdoor)	2 Year

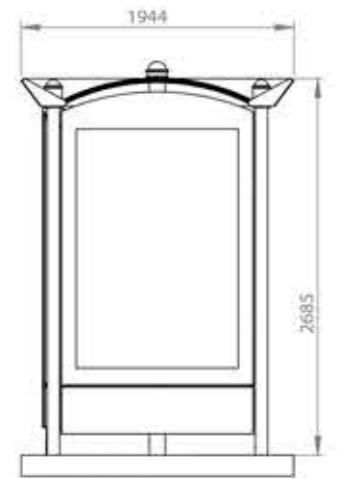
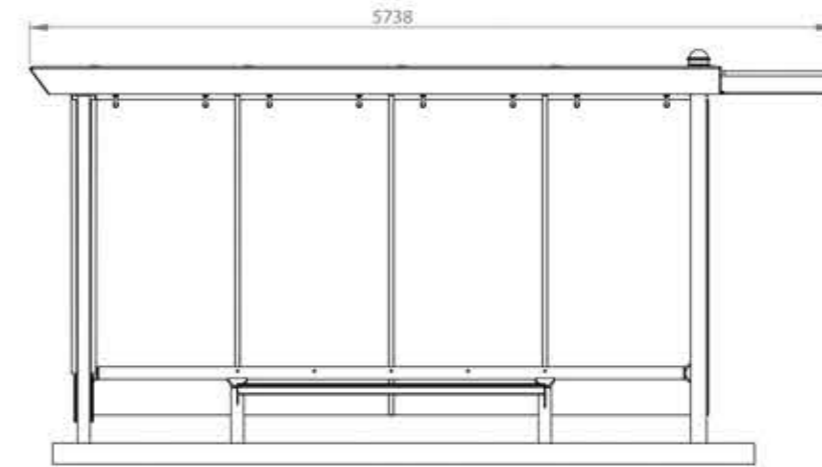

Ata Shelter



Technical Specifications

Product Dimensions	1680mm X 2324mm X 4180mm
Main Material	304 Quality Stainless Steel
Back Field	8 mm Tempered Glass
Roof	4mm Solid Polycarbonate
Ad Visible Area	1705mm X 1155mm
Scroller	Optional- Maximum 3 Ad
Lighting	Flourescent
Coating	Legs Polisaj, Roof Electrostatic Powder Coating (RAL Catalogue)
Galvanize	Iron Materials Hot Dip Galvanized
Guarantee (Outdoor)	2 Year

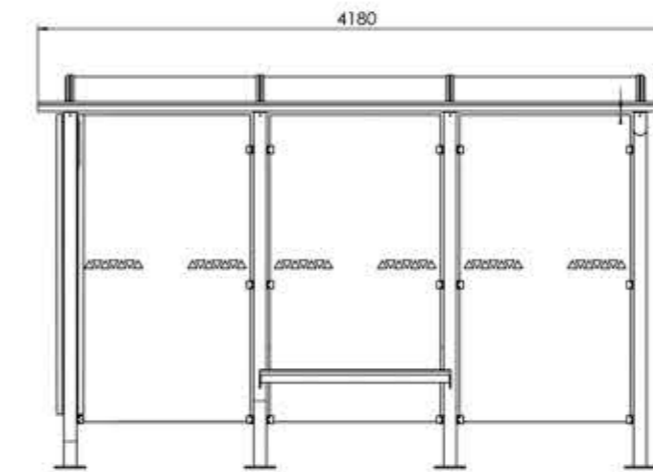

Green Shelter

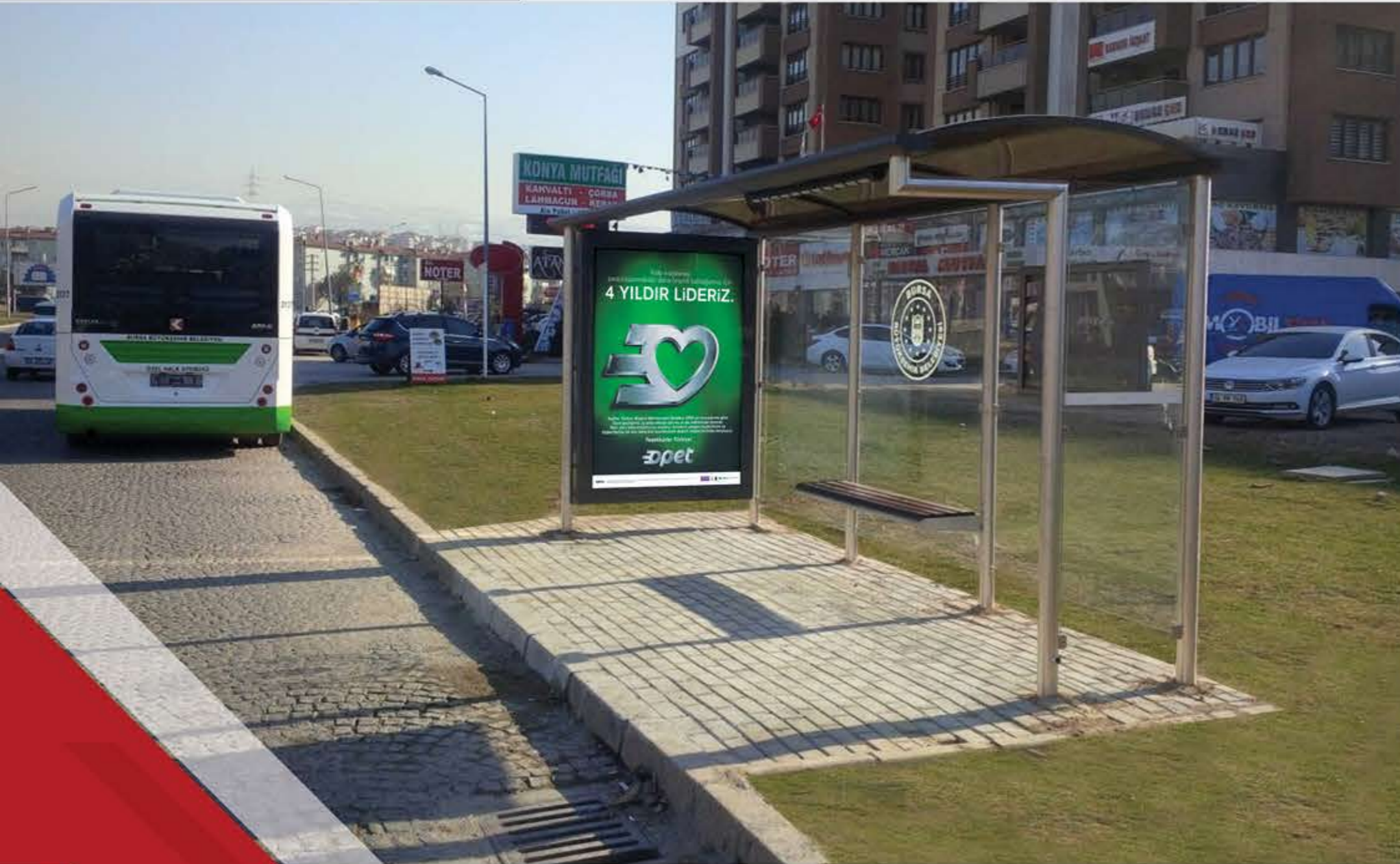

Technical Specifications

Product Dimensions	1724mm X 2520mm X 4800mm
Main Material	304 Quality Stainless Steel
Back Field	4mm Solid Polycarbonate
Roof	10 mm Tempered Glass
Ad Visible Area	1705mm X 1155mm
Scroller	Optional- Maximum 3 Ad
Lighting	Flourescent
Coating	Legs Polisaj, Roof Electrostatic Powder Coating (RAL Catalogue)
Galvanize	Iron Materials Hot Dip Galvanized
Guarantee (Outdoor)	2 Year

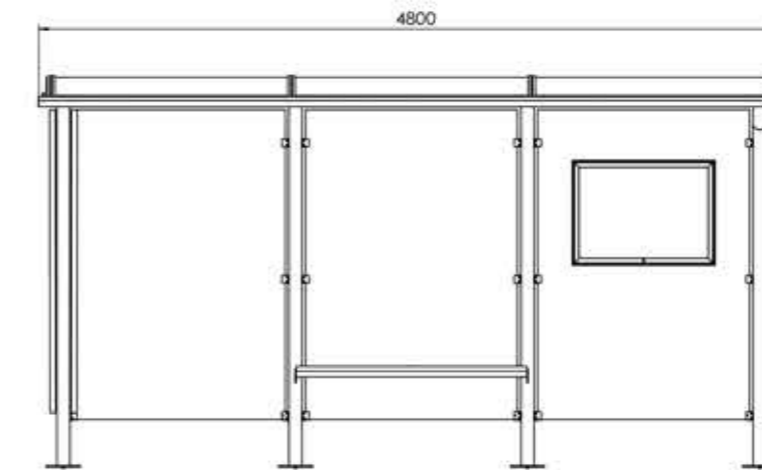

Körfez Shelter

Technical Specifications



Product Dimensions	1477mm X 2477 mm X 4100 mm
Main Material	304 Quality Stainless Steel
Back Field	10mm Tempered Glass
Roof	4mm Solid Polikarbonate
Ad Visible Area	1705mm X 1155mm
Scroller	Optional- Maximum 3 Ad
Lighting	Flourescent
Coating	Legs Polisaj, Roof Electrostatic Powder Coating (RAL Catalogue)
Galvanize	Iron Materials Hot Dip Galvanized
Guarantee (Outdoor)	2 Year

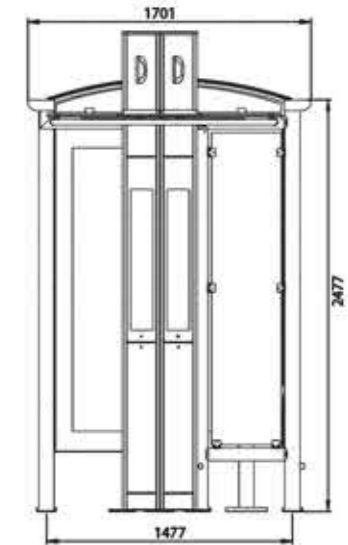
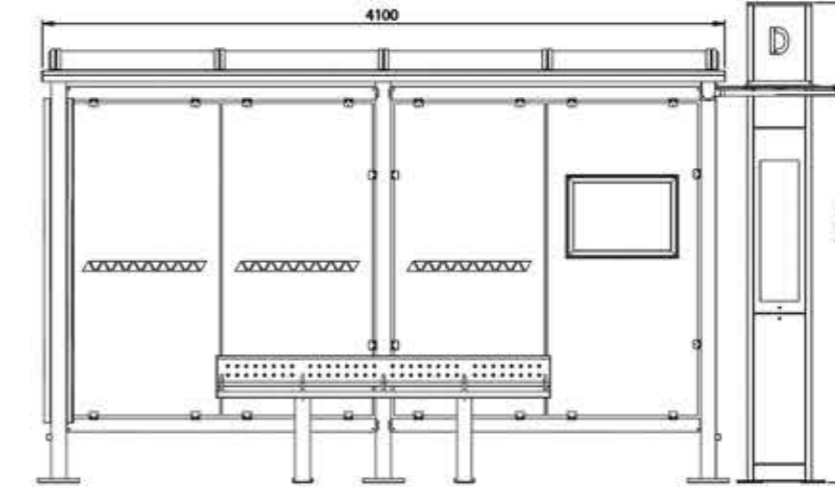

Anatolia Shelter

Technical Specifications



Product Dimensions	1812mm X 2403 mm X 4220 mm
Main Material	304 Quality Stainless Steel
Back Field	10mm Tempered Glass
Roof	4mm Solid Polikarbonate
Ad Visible Area	1705mm X 1155mm
Scroller	Optional- Maximum 3 Ad
Lighting	Flourescent
Coating	Legs Polisaj, Roof Electrostatic Powder Coating (RAL Catalogue)
Galvanize	Iron Materials Hot Dip Galvanized
Guarantee (Outdoor)	2 Year

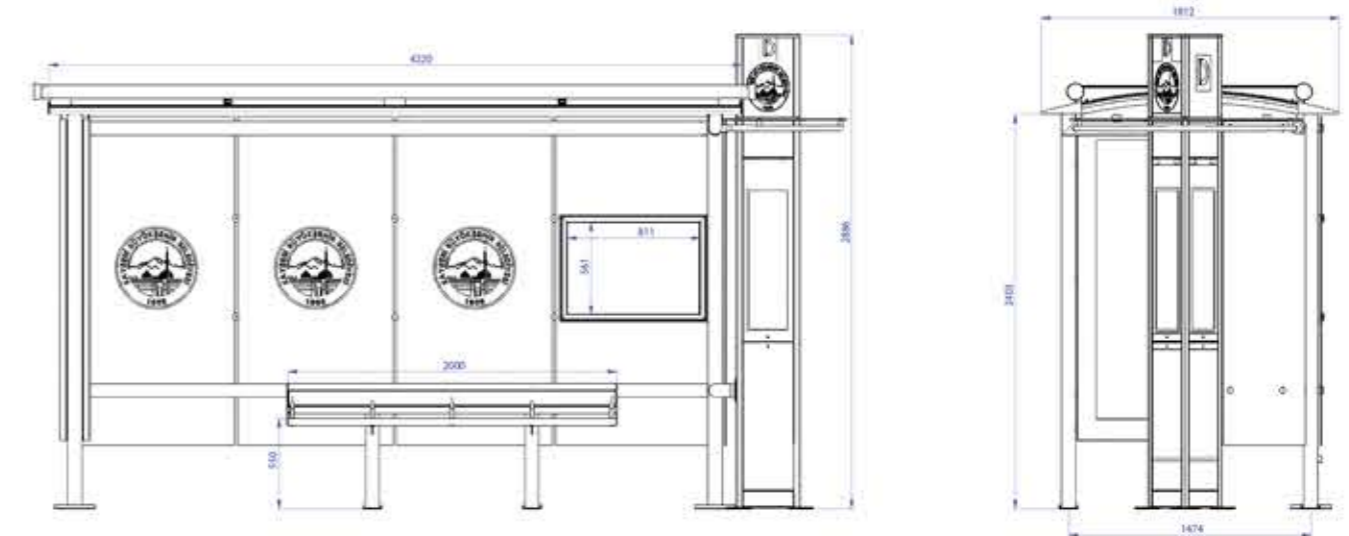

Blue Shelter

Technical Specifications

Product Dimensions	1758mm X 2474mm X 4560mm
Main Material	304 Quality Stainless Steel
Back Field	8mm tempered Glass
Roof	4mm Solid Polycarbonate
Ad Visible Area	1705mm X 1155mm
Scroller	Optional- Maximum 3 Ad
Lighting	Flourescent
Coating	Legs Polisaj, Roof Electrostatic Powder Coating (RAL Catalogue)
Galvanize	Iron Materials Hot Dip Galvanized
Guarantee (Outdoor)	2 Year

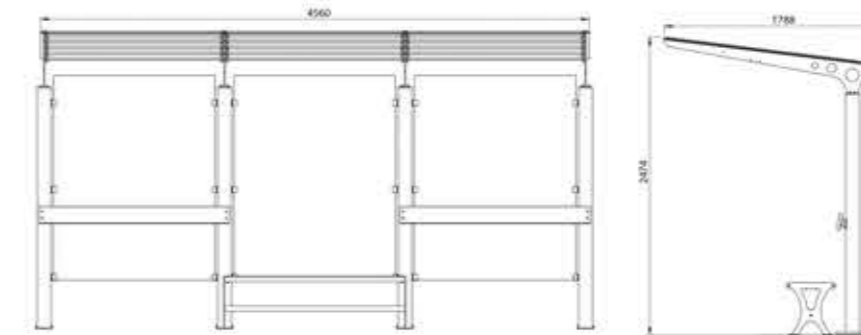

Junior Shelter Without Side Glass



Technical Specifications

Product Dimensions	922mm X 2625mm X 3965mm
Main Material	304 Quality Stainless Steel
Back Field	10mm tempered Glass
Roof	4mm Solid Polycarbonate
Ad Visible Area	1705mm X 1155mm
Scroller	Optional- Maximum 3 Ad
Lighting	Flourescent
Coating	Legs Polisaj, Roof Electrostatic Powder Coating (RAL Catalogue)
Galvanize	Iron Materials Hot Dip Galvanized
Guarantee (Outdoor)	2 Year

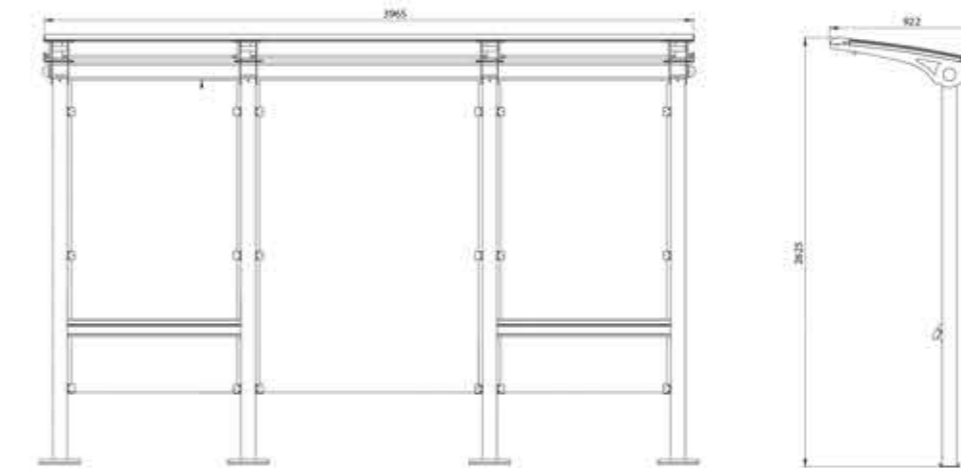

Modern Shelter

Technical Specifications

Product Dimensions	1393mm X 2637mm X 4665mm
Main Material	304 Quality Stainless Steel
Back Field	10mm tempered Glass
Roof	4mm Solid Polycarbonate
Ad Visible Area	1705mm X 1155mm
Scroller	Optional- Maximum 3 Ad
Lighting	Flourescent
Coating	Legs Polisaj, Roof Electrostatic Powder Coating (RAL Catalogue)
Galvanize	Iron Materials Hot Dip Galvanized
Guarantee (Outdoor)	2 Year

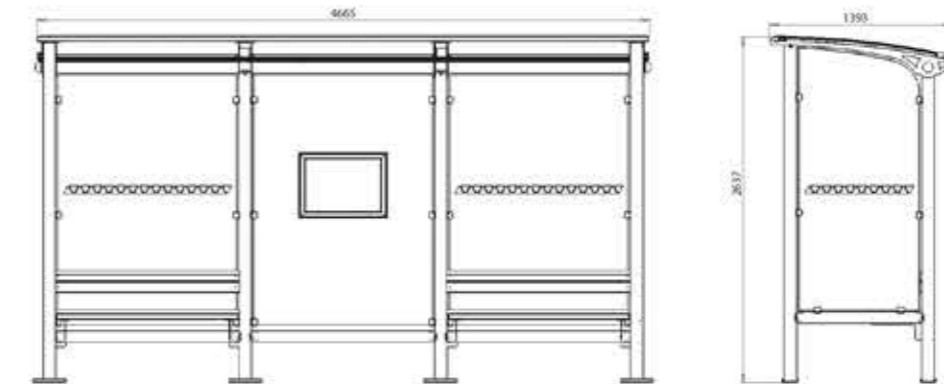

Junior Shelter

Technical Specifications

Product Dimensions	1043mm X 2628 mm X 3165 mm
Main Material	304 Quality Stainless Steel
Back Field	10mm tempered Glass
Roof	4mm Solid Polycarbonate
Ad Visible Area	1705mm X 1155mm
Scroller	Optional- Maximum 3 Ad
Lighting	Flourescent
Coating	Legs Polisaj, Roof Electrostatic Powder Coating (RAL Catalogue)
Galvanize	Iron Materials Hot Dip Galvanized
Guarantee (Outdoor)	2 Year

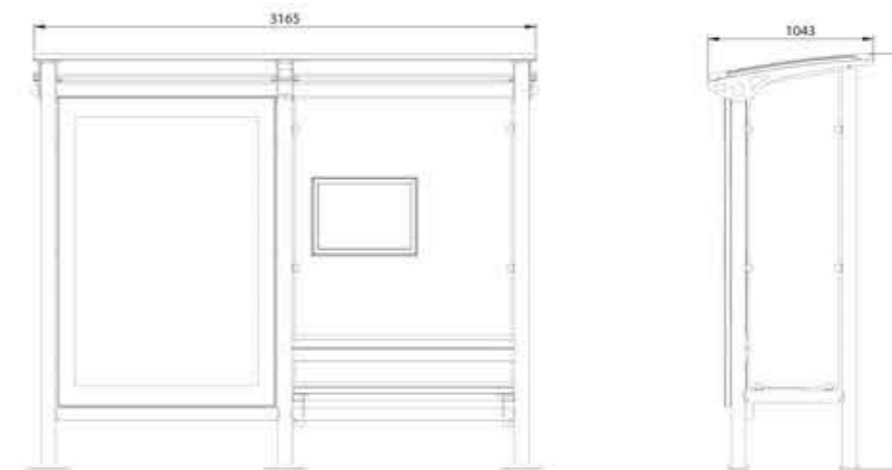

TOD 1002 Shelter

Technical Specifications



Product Dimensions	2000mm X 2322 mm X 4600 mm
Main Material	Steel Profile
Back Field	8mm Tempered Glass
Roof	10 mm Tempered Glass
Ad Visible Area	1705mm X 1155mm
Scroller	Optional- Maximum 3 Ad
Lighting	Flourescent
Coating	Electrostatic Powder Coating (RAL Catalogue)
Galvanize	Iron Materials Hot Dip Galvanized
Guarantee (Outdoor)	2 Year

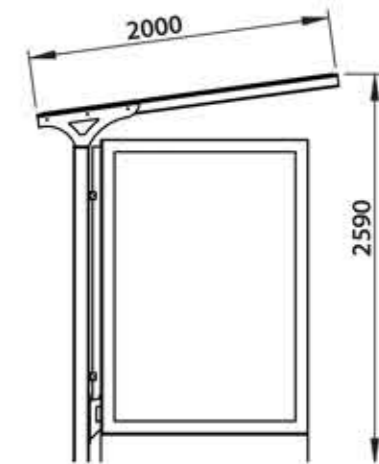
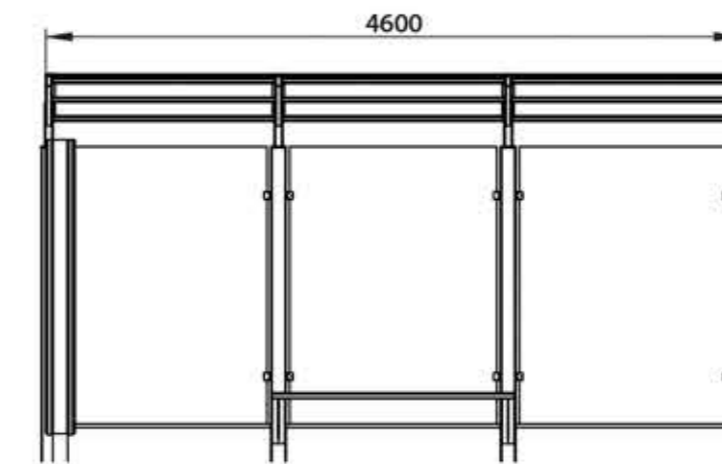

Scroller Shelter

Technical Specifications



Product Dimensions	1500mm X 2800 mm X 4000m
Main Material	Steel Profile
Back Field	8mm Tempered Glass
Roof	10 mm Tempered Glass
Ad Visible Area	1610mm x 3462mm
Scroller	Optional- Maximum 3 Ad
Lighting	Flourescent
Coating	Electrostatic Powder Coating (RAL Catalogue)
Galvanize	Iron Materials Hot Dip Galvanized
Guarantee (Outdoor)	2 Year

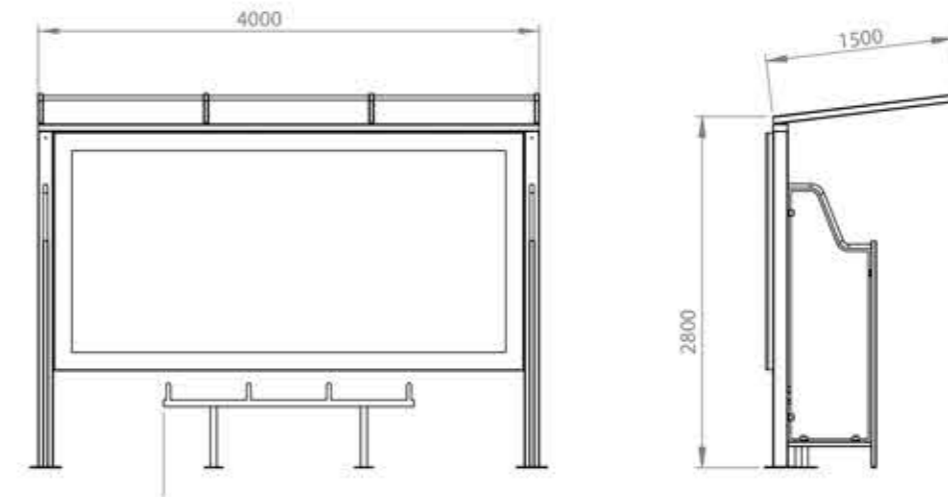

Green Peron Shelter



Technical Specifications

Product Dimensions	1724mm X 2520 mm X 7894 mm
Main Material	304 Quality Stainless Steel
Back Field	8mm Tempered Glass
Roof	4mm Solid Polycarbonate
Ad Visible Area	1705mm X 1155mm
Scroller	Optional- Maximum 3 Ad
Lighting	Flourescent
Coating	Legs Polisaj, Roof Electrostatic Powder Coating (RAL Catalogue)
Galvanize	Iron Materials Hot Dip Galvanized
Guarantee (Outdoor)	2 Year

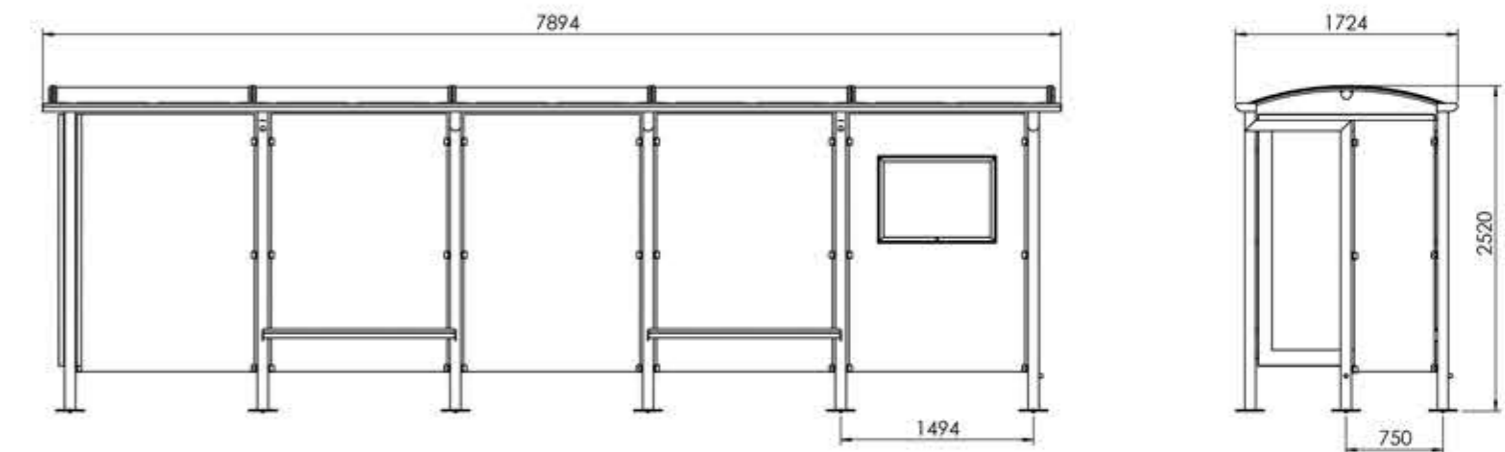

TOD 1002 Tramway Shelter

Technical Specifications



Product Dimensions	2545mm X 3166mm X 4560 mm
Main Material	Steel Profile
Back Field	8mm Tempered Glass
Roof	10 mm Tempered Glass
Ad Visible Area	1705mm X 1155mm
Scroller	Optional- Maximum 3 Ad
Lighting	Flourescent
Coating	Electrostatic Powder Coating (RAL Catalogue)
Galvanize	Iron Materials Hot Dip Galvanized
Guarantee (Outdoor)	2 Year

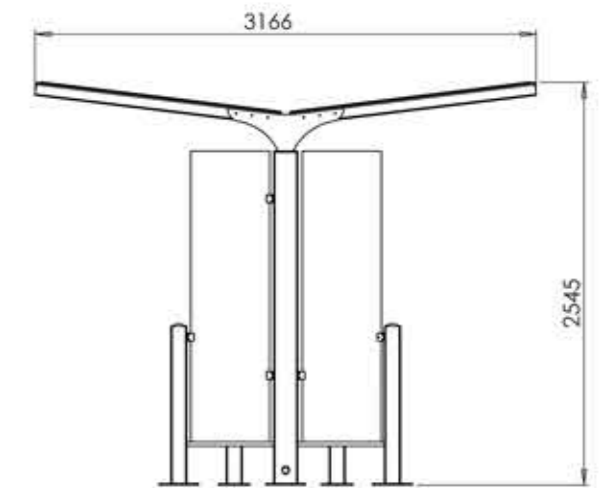
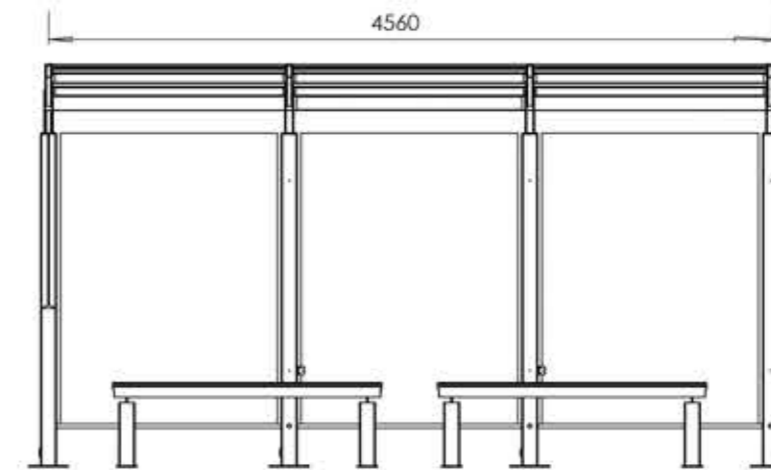

Xenon Tramway Shelter

Technical Specifications



Product Dimensions	2780mm X 3510mm X 4735mm
Main Material	Extruded Aluminium Profile
Back Field	8mm Tempered Glass
Roof	12mm Laminated Glass
Ad Visible Area	1705mm X 1155mm
Scroller	Optional- Maximum 3 Ad
Lighting	Flourescent
Coating	Electrostatic Powder Coating (RAL Catalogue)
Galvanize	Iron Materials Hot Dip Galvanized
Guarantee (Outdoor)	2 Year

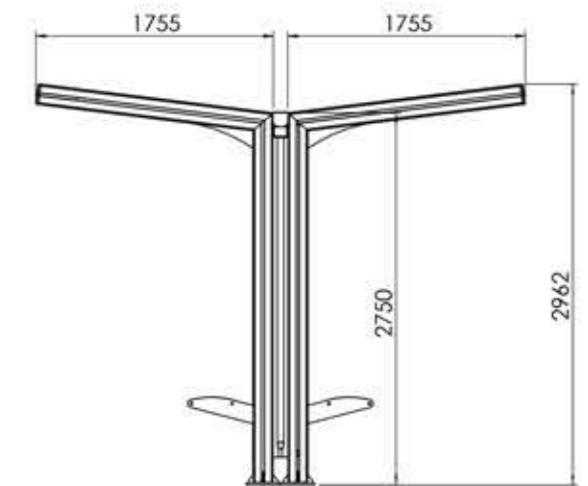
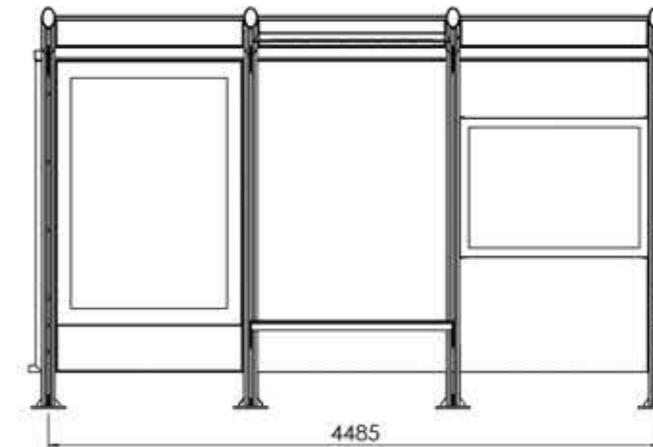

"KAYSERİ" Tramway Shelter - Side Platform



Technical Specifications

Product Dimensions	1818mm X 3400mm X 21068mm(Optional)
Main Material	304 Quality Stainless Steel
Back Field	10mm Tempered Glass
Roof	5mm Solid Polycarbonate
Lighting	Flourescent
Coating	Electropolisaj
Galvanize	Iron Materials Hot Dip Galvanized
Guarantee (Outdoor)	2 Year

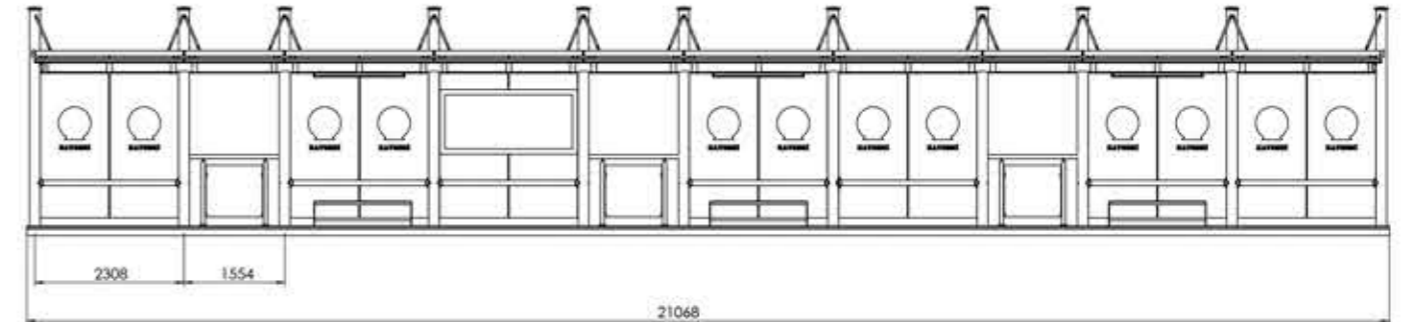

"KAYSERİ" Tramway Shelter - Middle Platform



Technical Specifications

Product Dimensions	3468mm X3400mm X 21068mm(Optional)
Main Material	304 Quality Stainless Steel
Back Field	10mm Tempered Glass
Roof	5mm Solid Polycarbonate
Lighting	Flourescent
Coating	Electropolisaj
Galvanize	Iron Materials Hot Dip Galvanized
Guarantee (Outdoor)	2 Year

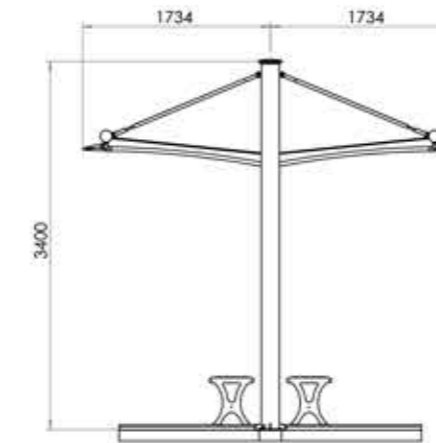
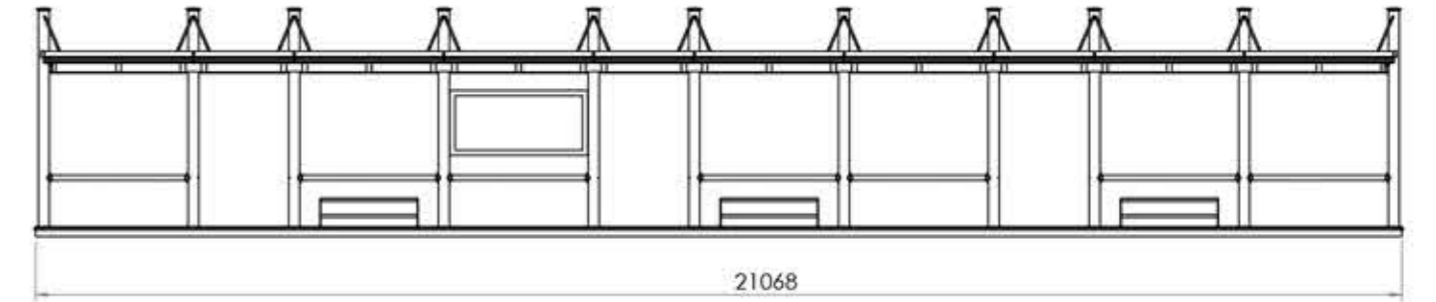

"ALGERIA" Tramway Shelter



Technical Specifications

Product Dimensions	2684mm x 3934mm x 10257mm(Optional)
Main Material	Steel
Back Field	4+4mm Laminated Glass
Roof	6mm Aluminium Composite Panel
Lighting	Flourescent
Coating	Electrostatic Powder Coating (Ral Catalog)

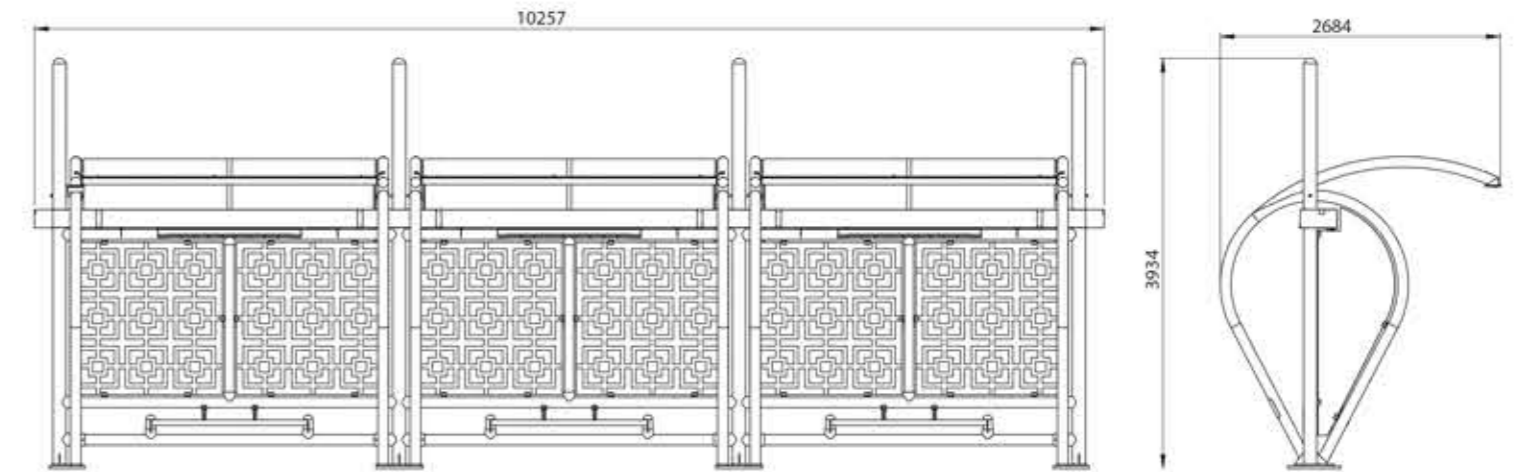

Alike Wiege Billboard



Technical Specifications

Height	3390mm
Wide	4130mm
Main Material	Steel Profile+ Extruded Aluminium Profile Cover
Poster Field	8mm Plywood
Surface Cover	Steel Profile+ Galvanized Steel Shee Cladding
Ad Visible Area	3485mm X 1985mm
Lighting	Flourescent
Coating	Electrostatic Powder Coating (RAL Catalogue)
Galvanize	Hot Dip Galvanized
Guarentee (Outdoor)	Metal 2 Year , Plywood 5 year

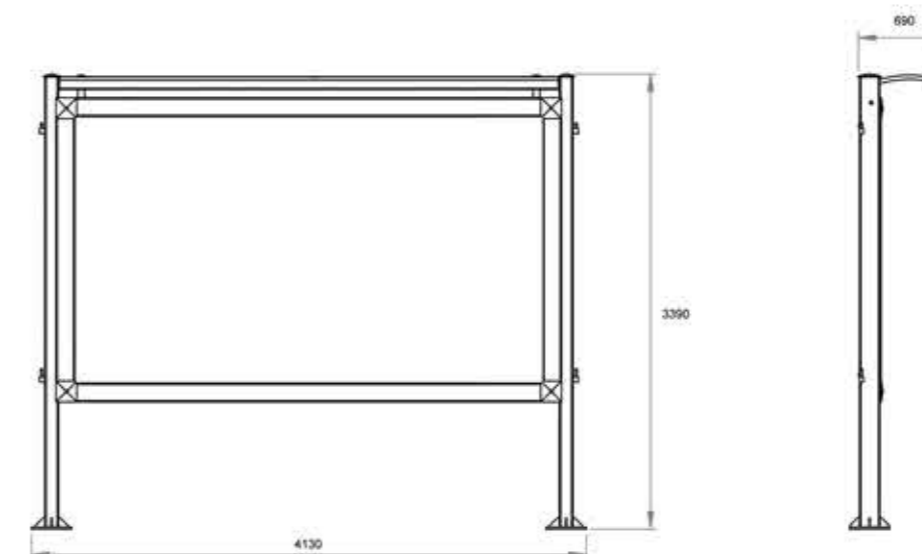

Turkuaz- Billboard



Technical Specifications

Height	3350mm
Wide	4130mm
Main Material	Steel Profile+ Extruded Aluminium Profile Cover
Poster Field	8mm Plywood
Surface Cover	Extruded Aluminium Profile Cover
Ad Visible Area	3493mm x 1982mm
Lighting	Flourescent
Coating	Electrostatic Powder Coating (RAL Catalogue)
Galvanize	Hot Dip Galvanized
Guarantee (Outdoor)	2 year

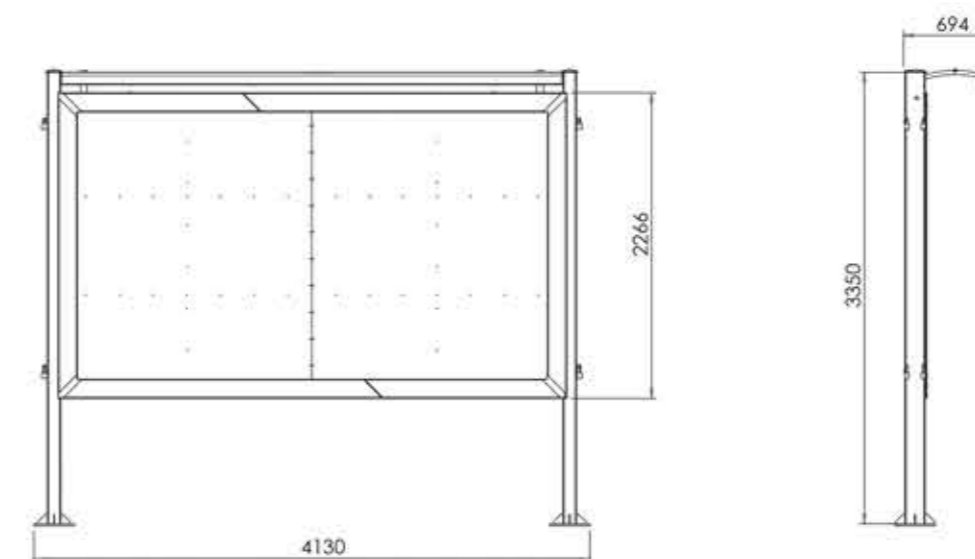

Luna- Billboard

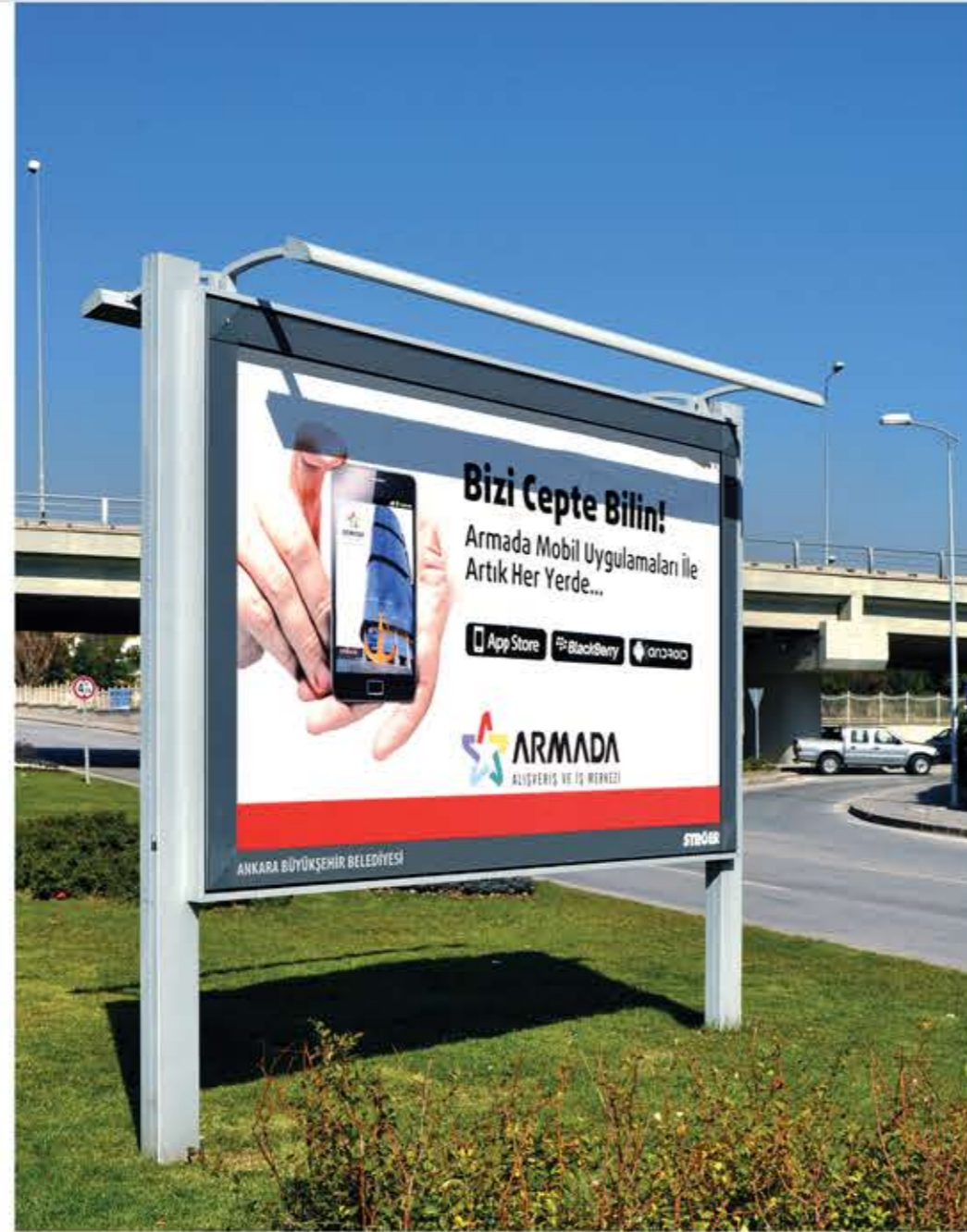

Technical Specifications

Height	3600mm
Wide	4227mm
Main Material	Steel Profile+ Extruded Aluminium Profile Cover
Poster Field	8mm Plywood
Surface Cover	Extruded Aluminium Profile Cover
Ad Visible Area	3465mm X 1965mm
Lighting	Flourescent
Coating	Electrostatic Powder Coating (RAL Catalogue)
Galvanize	Hot Dip Galvanized
Guarentee (Outdoor)	Metal 2 Year , Plywood 5 year

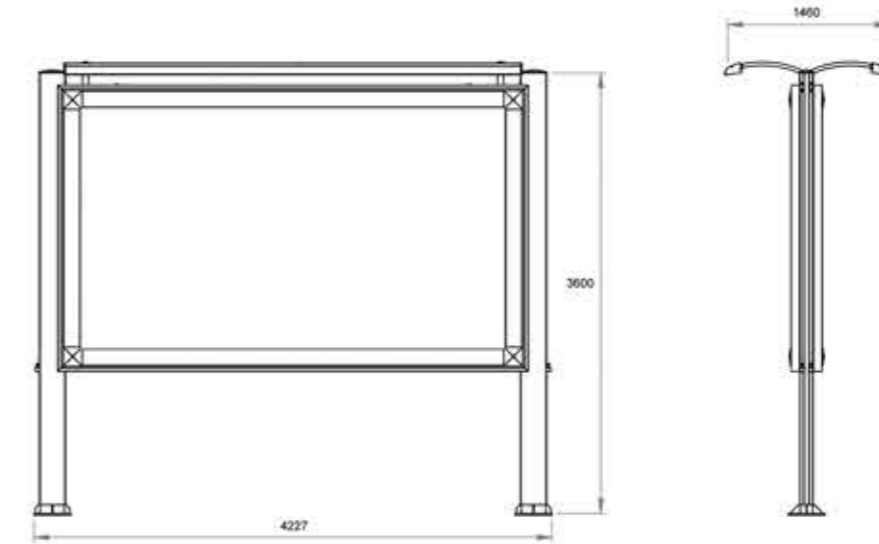

Wiege - Billboard



Technical Specifications

Height	3640mm
Wide	4227mm
Main Material	Steel Profile + Extruded Aluminium Profile Cover
Poster Field	8mm Plywood
Surface Cover	Extruded Aluminium Profile Cover
Ad Visible Area	3465mm X 1965mm
Lighting	Flourescent
Coating	Electrostatic Powder Coating (RAL Catalogue)
Galvanize	Hot Dip Galvanized
Guarentee (Outdoor)	Metal 2 Year , Plywood 5 year

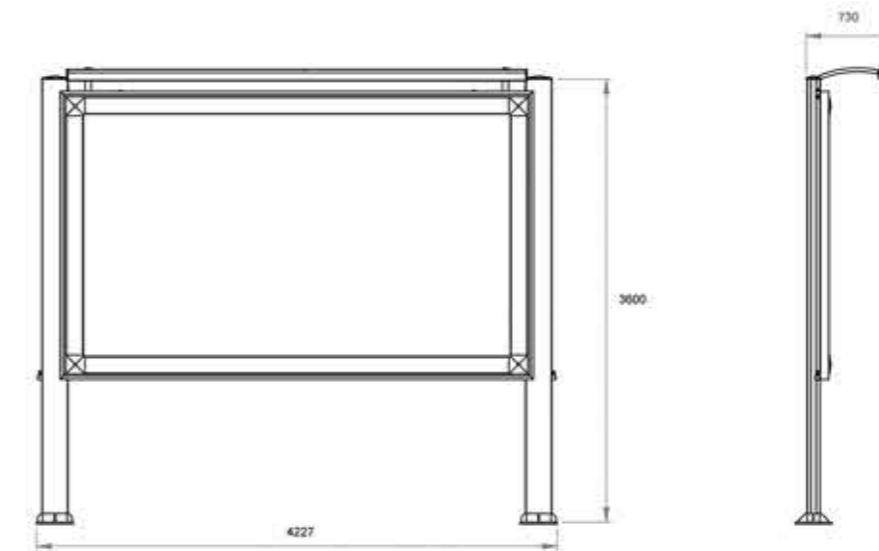

Classic Billboard

Technical Specifications



Height	3490mm
Wide	3910mm
Main Material	Steel Profile+ Extruded Aluminium Profile Cover
Poster Field	8mm Plywood
Body Cover	Extruded Aluminium Profile Cover
Ad Visible Area	3427mm X 1947mm
Lighting	Flourescent
Coating	Electrostatic Powder Coating (RAL Catalogue)
Galvanize	Hot Dip Galvanized
Guarentee (Outdoor)	Metal 2 Year , Plywood 5 year.

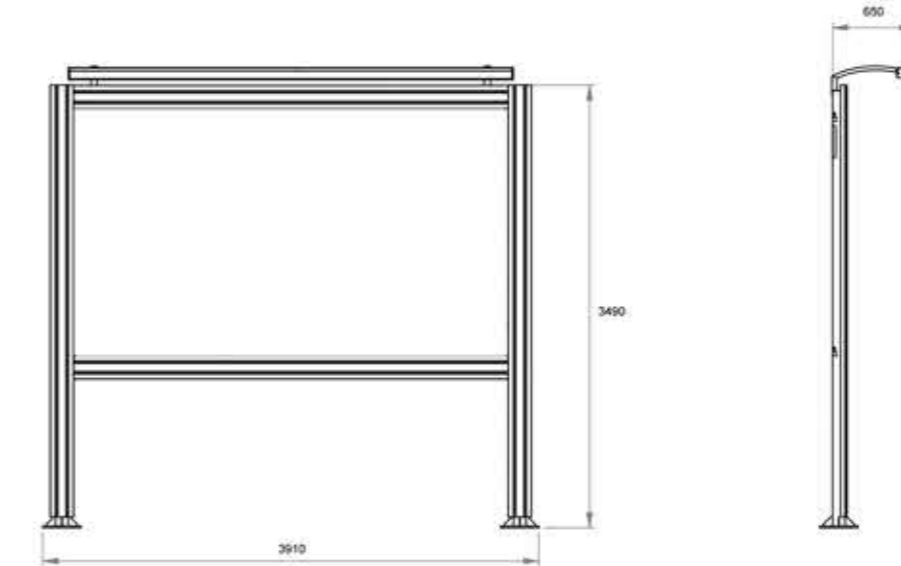

Premium Billboard

Technical Specifications



Height	3090mm
Wide	3752mm
Main Material	Steel Profile+ Extruded Aluminium Profile Cover
Poster Field	10 mm Tempered Glass
Surface Cover	Extruded Aluminium Profile Cover
Ad Visible Area	3462mm X 1950mm
Lighting	Flourescent- Led
Coating	Electrostatic Powder Coating (RAL Catalogue)
Galvanize	Hot Dip Galvanized
Guarantee (Outdoor)	2 year
Scrolling	As Request (Maximum 3 Poster)

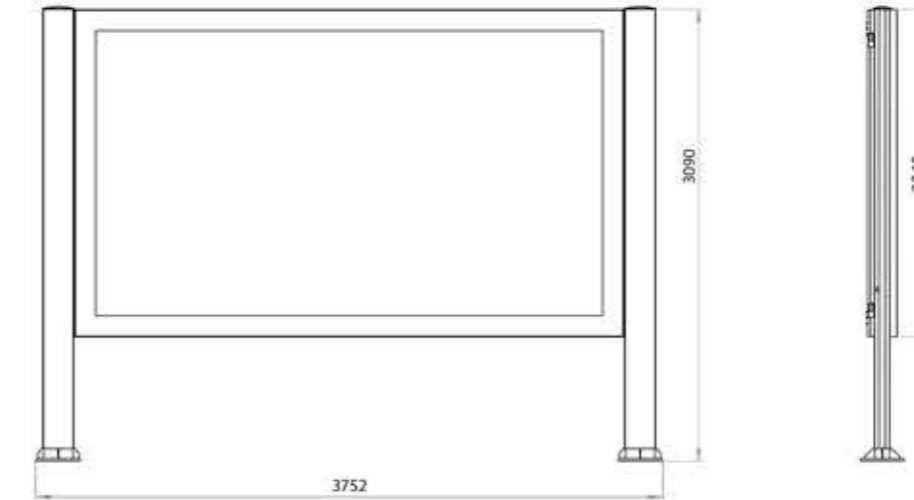



Product Dimensions	2692mm X 1372mm X 180mm
Main Material	Steel Profile + Extruded Aluminum Profile
Poster Field	Bilateral-6mm Tempered Glass-Paspartu
Surface Cover	Body: Aluminum Cover / Leg: Metal Sheet and Glass
Ad Visible Area	1705mm X 1155mm
Scroller	As Request-Maximum 3 Poster
Lighting	Flourescent
Coating	Electrostatic Powder Coating (RAL Catalogue)
Galvanize	Iron Material Hot Dip Galvanized
Guarantee (Outdoor)	2 year

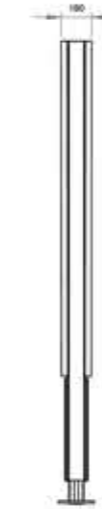
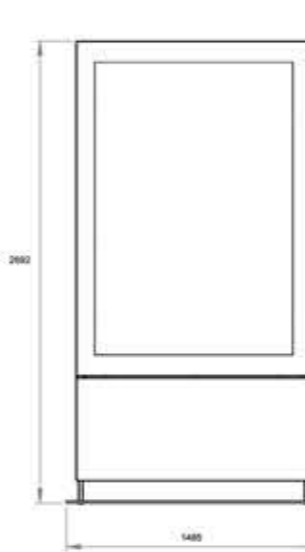

Talas CLP

Technical Specifications



Product Dimensions	1446mm X 2700mm X 194mm
Main Material	Steel Profile + Extruded Aluminum Profile
Poster Field	Bilateral mm 6mm Tempered Glass-Paspartu
Surface Cover	Body: Aluminum Cover / Leg: Metal Sheet and Glass
Ad Visible Area	1705mm X 1155mm
Scroller	As Request-Maximum 3 Poster
Lighting	Flourescent
Coating	Electrostatic Powder Coating (RAL Catalogue)
Galvanize	Iron Material Hot Dip Galvanized
Guarantee (Outdoor)	2 year

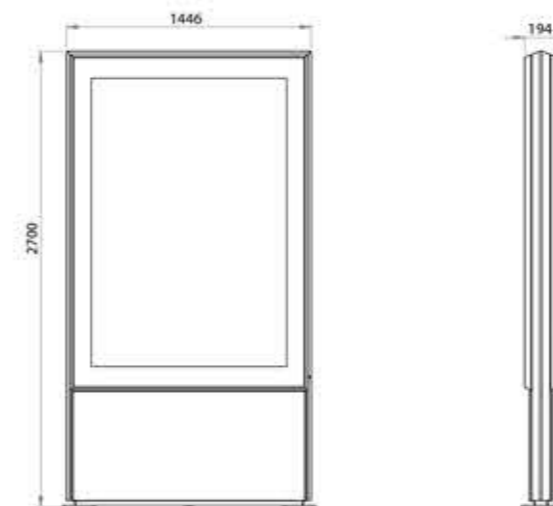



Product Dimensions	1372mm X 2300mm X 178mm
Main Material	Steel Profile + Extruded Aluminum Profile
Back Field	Bilateral-6mm Tempered Glass-Paspartu
Surface Roof	Body: Aluminum Cover / Leg: Metal Sheet and Glass
Ad Visible Area	1705mm X 1155mm
Scroller	As Request-Maximum 3 Poster
Lighting	Flourescent
Coating	Electrostatic Powder Coating (RAL Catalogue)
Galvanize	Iron Meterial Hot Dip Galvanized
Guarantee (Outdoor)	2 year

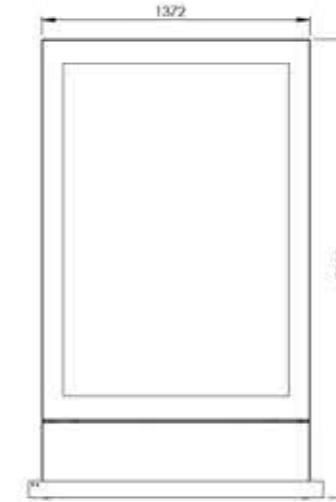

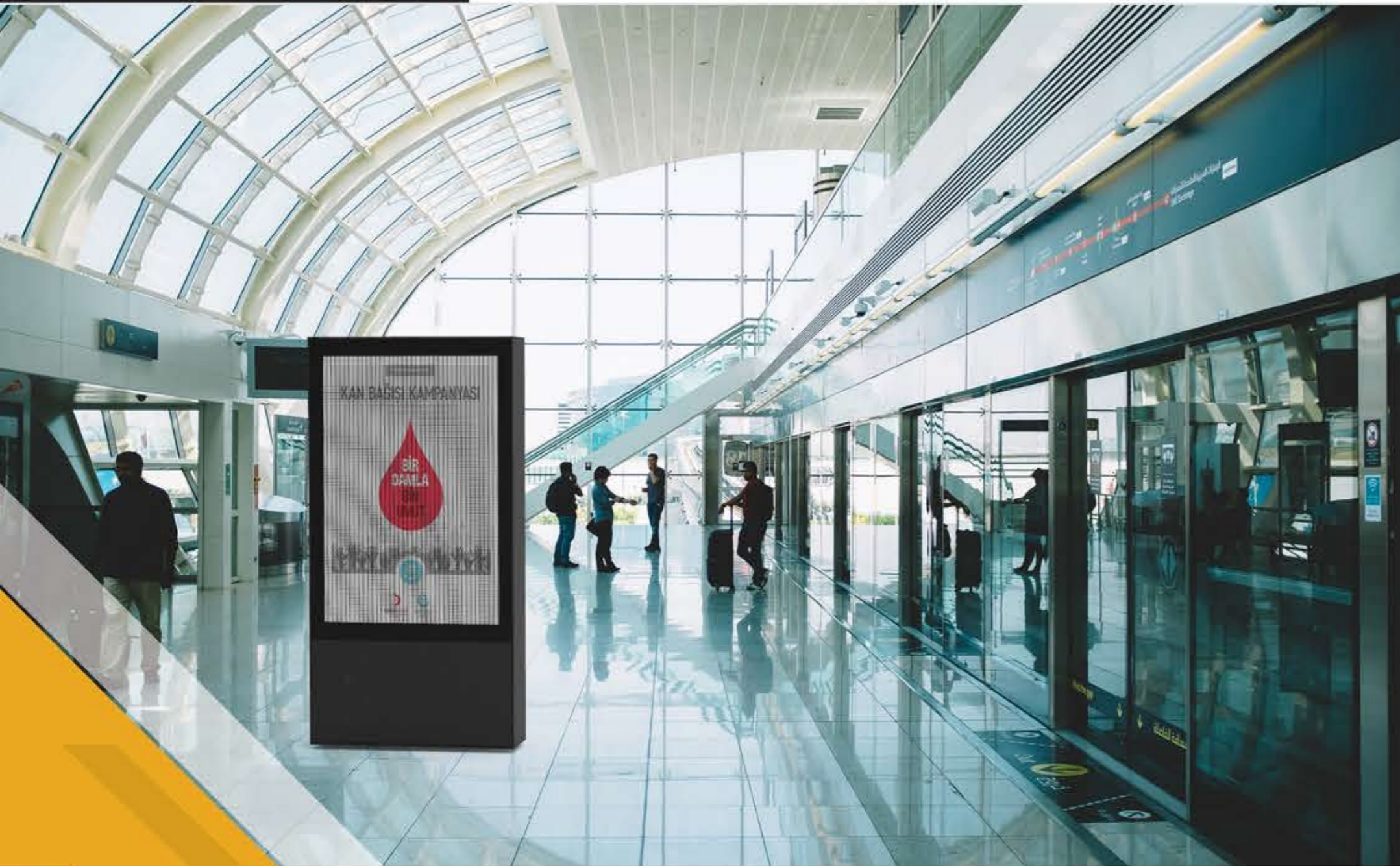

Product Dimensions	1181mm X 2300mm X 308mm
Main Material	Steel Profile + Aluminum Cover
Back Field	Double - Sided Led Screen
Ad Visible Area	1000mm X 1500mm
Coating	Electrostatic Powder Coating (RAL Catalogue)
Galvanize	Iron Material Hot Dip Galvanized
Guarantee (Outdoor)	2 year

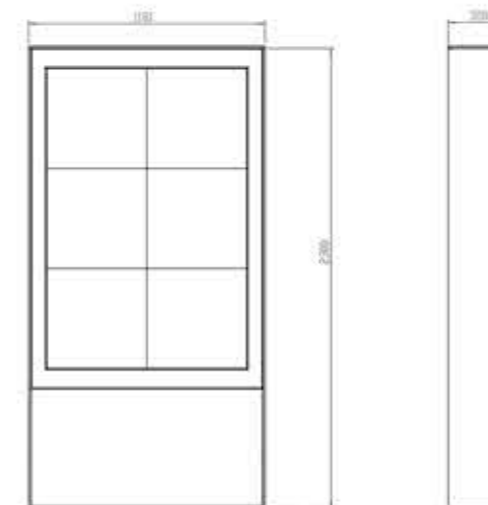

Curved CLP



Technical Specifications

Product Dimensions	1476mm X 2075 mm X 320mm
Main Material	Steel Profile + Extruded Aluminum Profile
Back Field	Bilateral mm -6mm Tempered Glass-Paspartu
Surface Roof	Body: Aluminum Cover / Leg: Metal Sheet and Glass
Ad Visible Area	1695mm X 1116mm
Scroller	As Request-Maximum 3 Poster
Lighting	Flourescent
Coating	Electrostatic Powder Coating (RAL Catalogue)
Galvanize	Iron Material Hot Dip Galvanized
Guarantee (Outdoor)	2 year

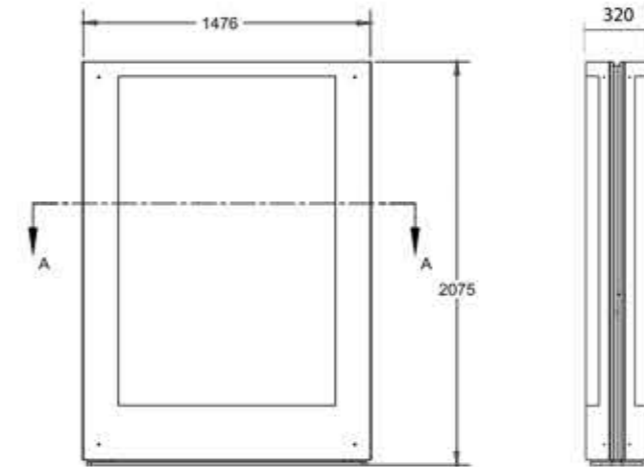



Product Dimensions	1372mm X 2300mm X 178mm
Main Material	Steel Profile + Extruded Aluminum Profile
Back Field	Bilateral-6mm Tempered Glass-Paspartu
Surface Roof	Body: Aluminum Cover / Leg: Metal Sheet and Glass
Ad Visible Area	1705mm X 1155mm
Scroller	As Request-Maximum 3 Poster
Lighting	Flourescent
Coating	Electrostatic Powder Coating (RAL Catalogue)
Galvanize	Iron Material Hot Dip Galvanized
Guarantee (Outdoor)	2 year



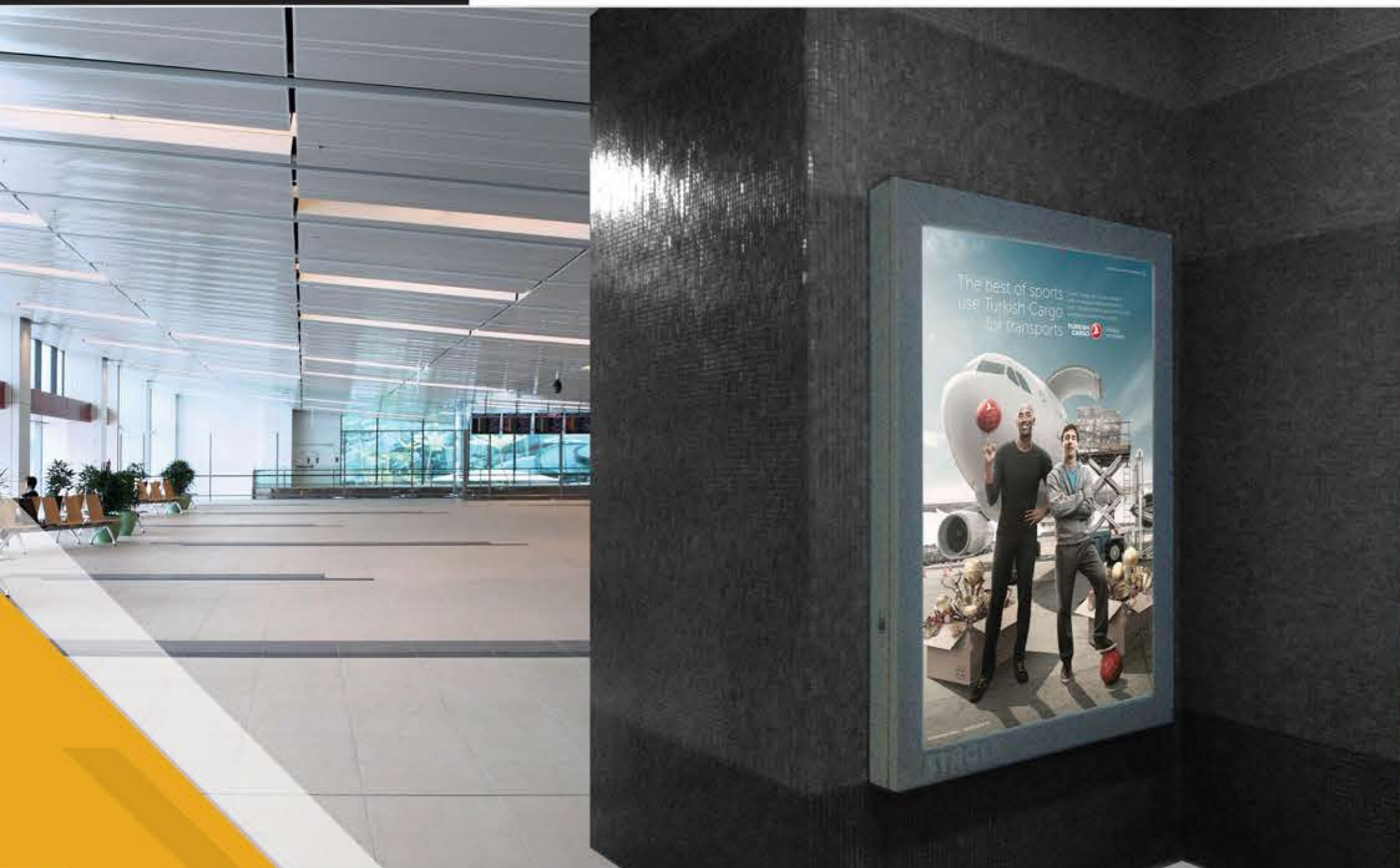

Product Dimensions	1403mm X 1953
Main Material	Steel Profile + Extruded Aluminum Profile
Poster Field	Bilateral mm 6mm Tempered Glass-Paspartu
Surface Cover	Body: Aluminum Cover / Leg: Metal Sheet and Glass
Ad Visible Area	1705mm X 1155mm
Scroller	As Request-Maximum 3 Poster
Lighting	Flourescent
Coating	Electrostatic Powder Coating (RAL Catalogue)

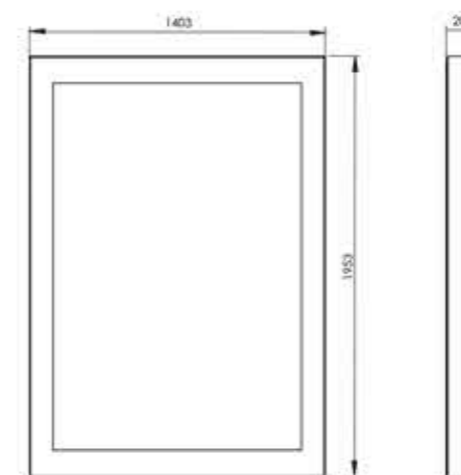

Metro Wall Megalight



Technical Specifications

Product Dimensions	3000mm X 2000mm X 200mm
Main Material	Extruded Aluminum Profile
Surface Cover	Extruded Aluminum Profile Cover
Ad Visible Area	1710mm X 2710mm
Lighting	Backlit
Coating	Electrostatic Powder Coating (RAL Catalogue)
Galvanize	Iron Material Hot Dip Galvanized
Guarantee (Outdoor)	2 year

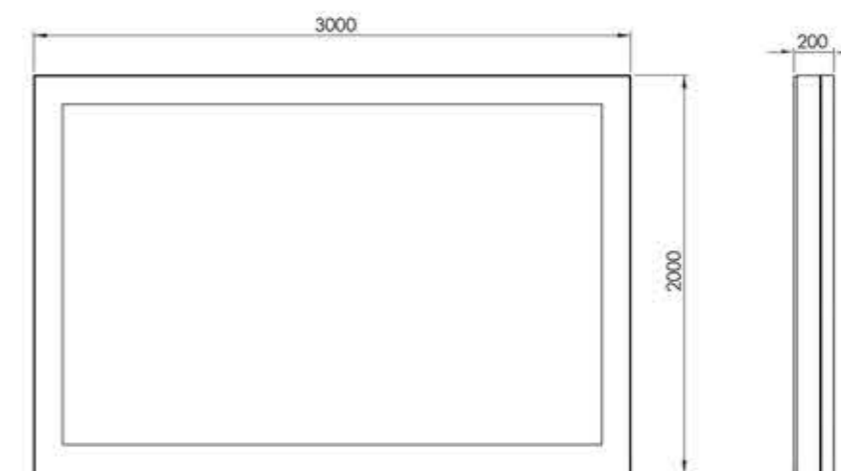

Lightboxes

Technical Specifications



Product Dimensions	6000mm X 2000mm X 335mm
Main Material	Steel Profile + Extruded Aluminum Profile
Surface Cover	Extruded Aluminum Profile Cover
Lighting	Backlit
Coating	Electrostatic Powder Coating (RAL Catalogue)
Galvanize	Iron Material Hot Dip Galvanized
Leg	3 Unit Carrier Leg
Guarantee (Outdoor)	2 year

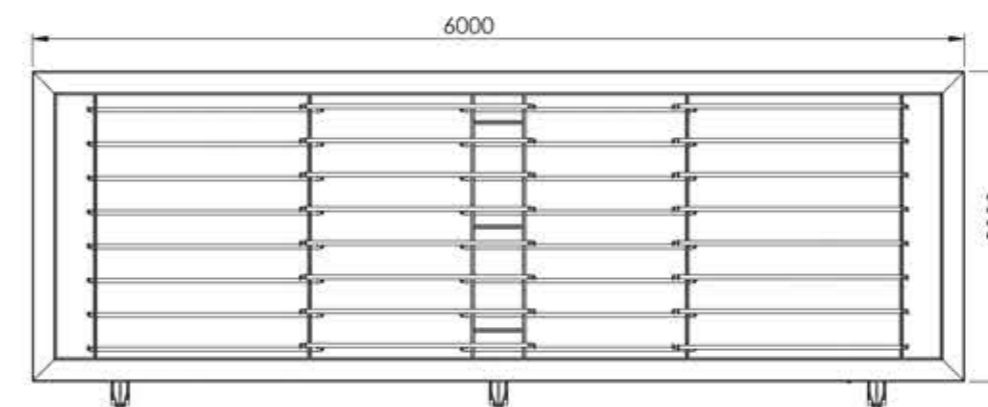



Product Dimensions	4800mm X 2300mm X 220mm
Main Material	Steel Profile + Extruded Aluminum Profile
Surface Cover	Extruded Aluminum Profile Cover
Lighting	Backlit
Coating	Electrostatic Powder Coating (RAL Catalogue)
Galvanize	Iron Material Hot Dip Galvanized
Leg	3 Unit Carrier Leg
Guarantee (Outdoor)	2 year

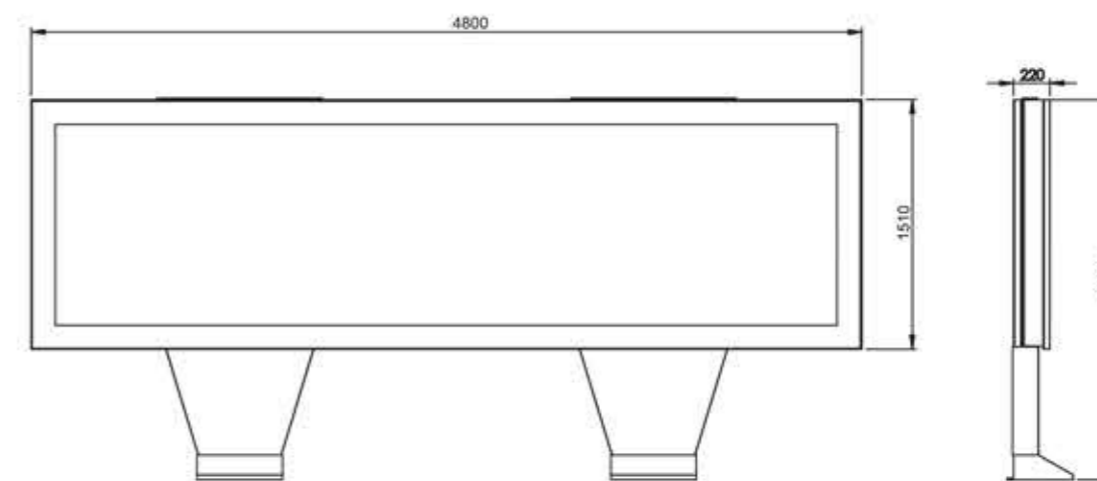

Lightboxes



Technical Specifications

Product Dimensions	2017mm X1502mm X 259 mm
Main Material	Steel Profile + Extruded Aluminum Profiles
Surface Cover	10mm Tempered Glass-Paspartu
Ad Visible Area	1725mm X 1210 mm
Lighting	Backlit
Coating	Electrostatic Powder Coating (RAL Catalogue)
Galvanize	Iron Material Hot Dip Galvanized
Leg	1 Unit Carrier Leg
Guarantee (Outdoor)	2 year

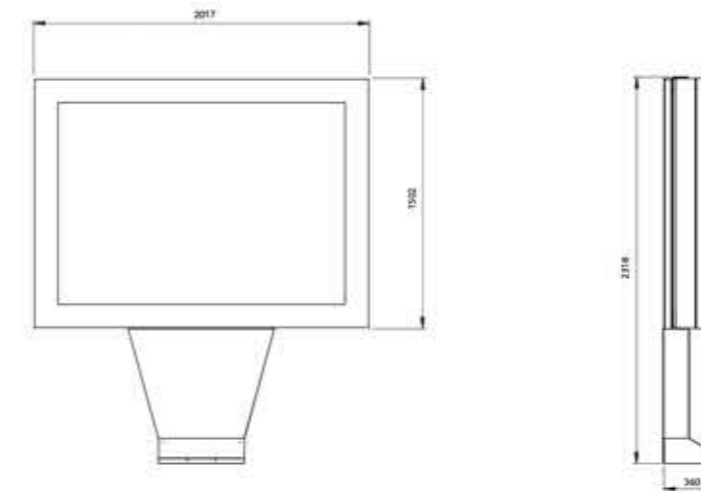



Product Dimensions	2132mm X 3014mm X 203mm
Main Material	Extruded Aluminum Profile
Surface Cover	Extruded Aluminum Profile Cover
Ad Visible Area	1230mm x 2744mm
Lighting	Backlit
Coating	Electrostatic Powder Coating (RAL Catalogue)
Galvanize	Iron Material Hot Dip Galvanized
Guarantee (Outdoor)	2 year

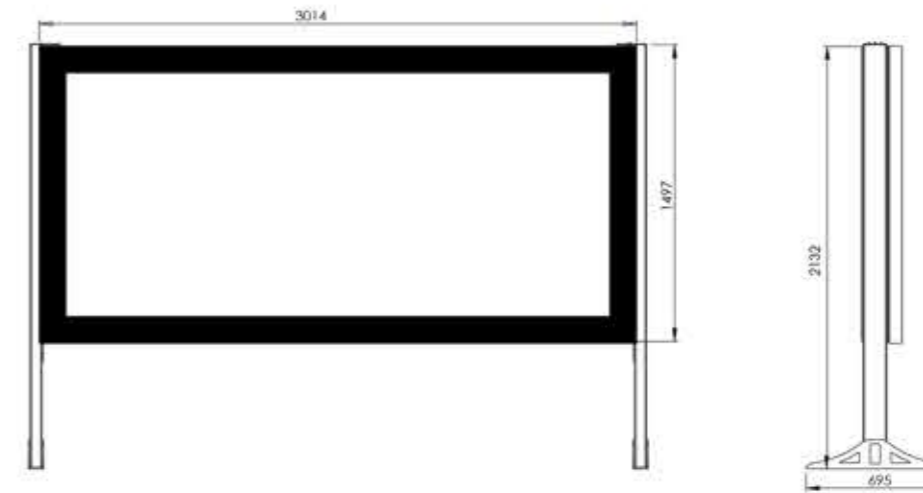

Erciyes Megalight

Technical Specifications



Product Dimensions	5064mm X 3370mm X 420mm
Main Material	Extruded Aluminum Profile + Steel Profile
Both Field	Bilateral - 10 mm Tempered Glass- Paspartu
Cladding	Extruded Aluminum Profile Cover
Ad Visible Area	2072mm X 3078mm
Scroller	Backlit Fluorescent
Lighting	Optional- Maximum 3 Poster
Coating	Electrostatic Powder Coating (RAL Catalogue)
Galvanize	Iron Material Hot Dip Galvanized
Guarantee (Outdoor)	2 year

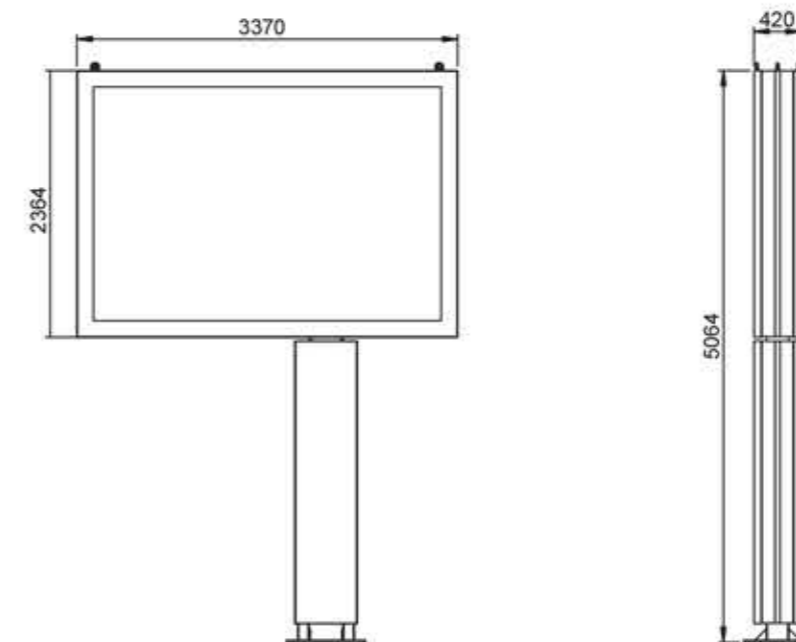



Product Dimensions	5430mm X 3755mm X 554mm
Main Material	Extruded Aluminum Profile + Steel Profile
Both Field	Bilateral - 10 mm Tempered Glass- Paspantu
Cladding	Extruded Aluminum Profile Cover
Ad Visible Area	2452mm X 3415mm
Scroller	Backlit Flourescent
Lighting	Optional- Maximum 3 Poster
Coating	Electrostatic Powder Coating (RAL Catalogue)
Galvanize	Iron Meterial Hot Dip Galvanized
Guarantee (Outdoor)	2 year

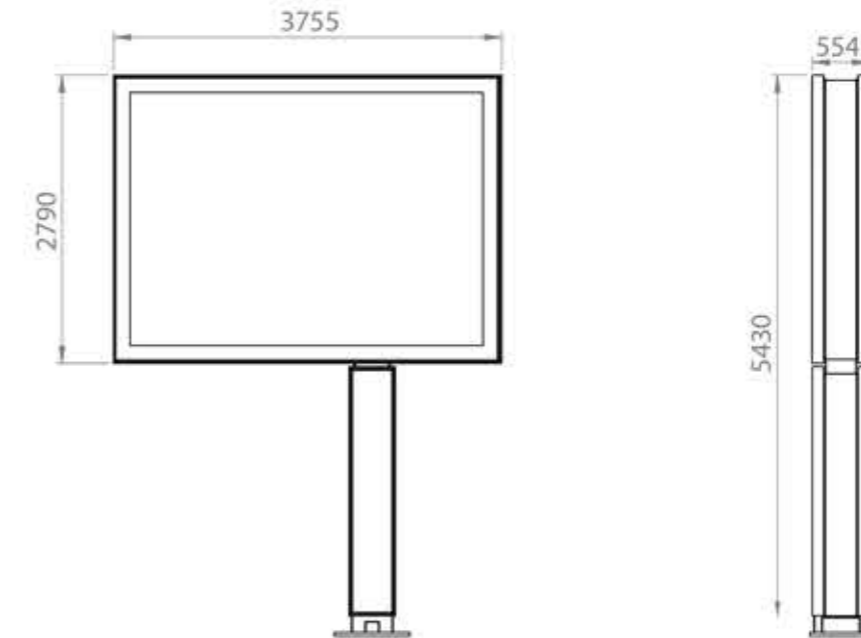

Big Wiege Megalight

Technical Specifications



Product Dimensions	3902mm X 5643 mm X 420 mm
Main Material	Aluminium Extrude Profile+ Steel Profile
Back Field	8mm Tempered Glass
Ad Visible Area	2453mm X 3416mm
Scroller	Optional- Maximum 3 Ad
Lighting	Flourescent
Coating	Electrostatic Powder Coating (RAL Catalogue)
Galvanize	Iron Materials Hot Dip Galvanized
Guarantee (Outdoor)	2 Year

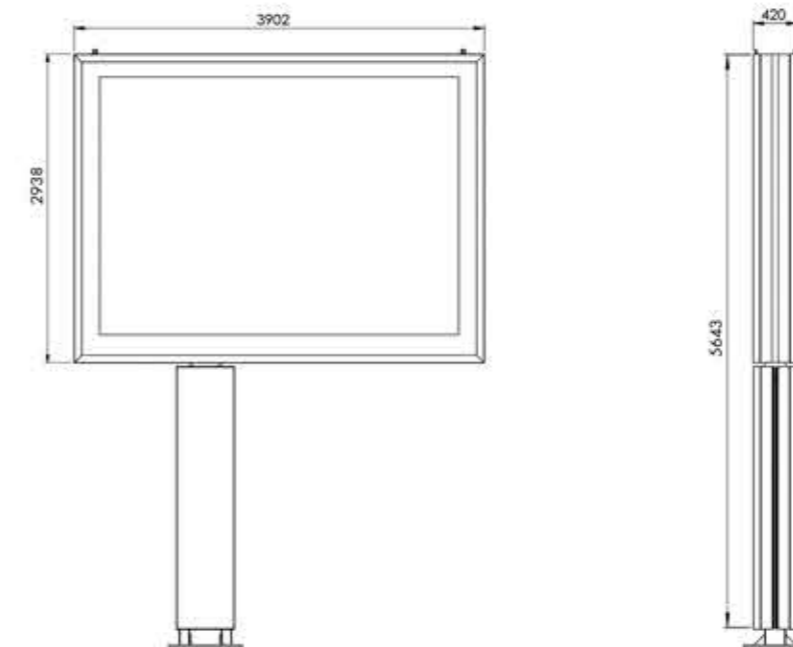

Megaboard



Technical Specifications

Product Dimensions	6130mm X 3143mm X 550mm
Main Material	Extruded Aluminum Profile + Steel Profile
Both Field	Bilateral - 10 mm Tempered Glass- Paspantu
Cladding	Extruded Aluminum Profile Cover
Ad Visible Area	2800mm X 5787mm
Lighting	Backlit Fluorescent
Scroller	Optional- Maximum 3 Poster
Coating	Electrostatic Powder Coating (RAL Catalogue)
Galvanize	Iron Material Hot Dip Galvanized
Guarantee (Outdoor)	2 year

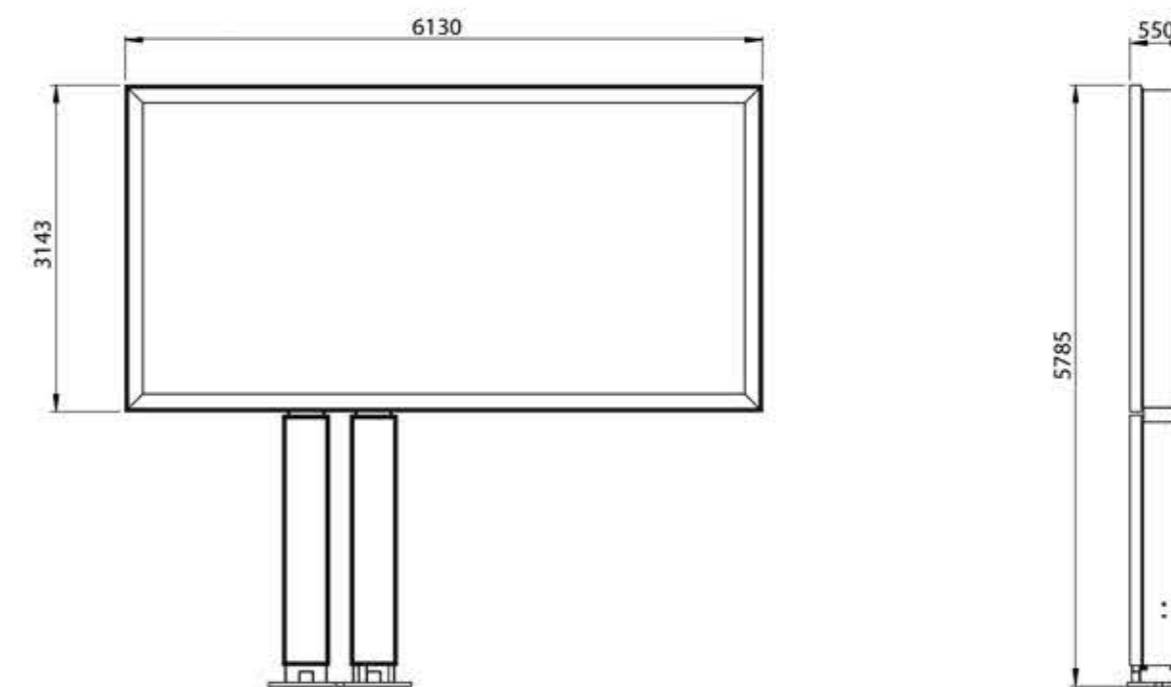



Product Dimensions	5185mm X 7946mm X 1055mm
Main Material	Extruded Aluminum Profile + Steel Profile
Leg All Sides	6 mm Tempered Glass
Cladding	Extruded Aluminum Profile Cover
Ad Visible Area	4511mm X 3390mm
Lighting	Led
Scroller	Optional- Maximum 3 Poster
Coating	Electrostatic Powder Coating (RAL Catalogue)
Galvanize	Iron Material Glass Beaded
Led	Led 16 mm Pixel
Guarantee (Outdoor)	2 year

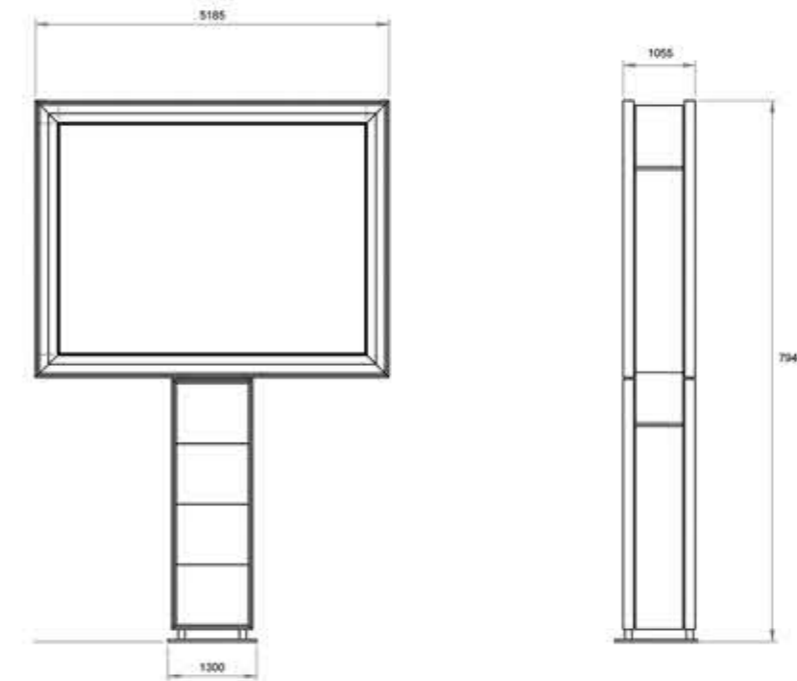



Product Dimensions	3260mm X 5260mm X 13000mm
Main Material	Extruded Aluminum Profile + Steel Profile
Cladding	Cover, Extruded Aluminium Profile, Leg, Aluminium Cover
Ad Visible Area	3000mm X 5000mm
Lighting	Led
Coating	Electrostatic Powder Coating (RAL Catalogue)
Guarantee (Outdoor)	2 year

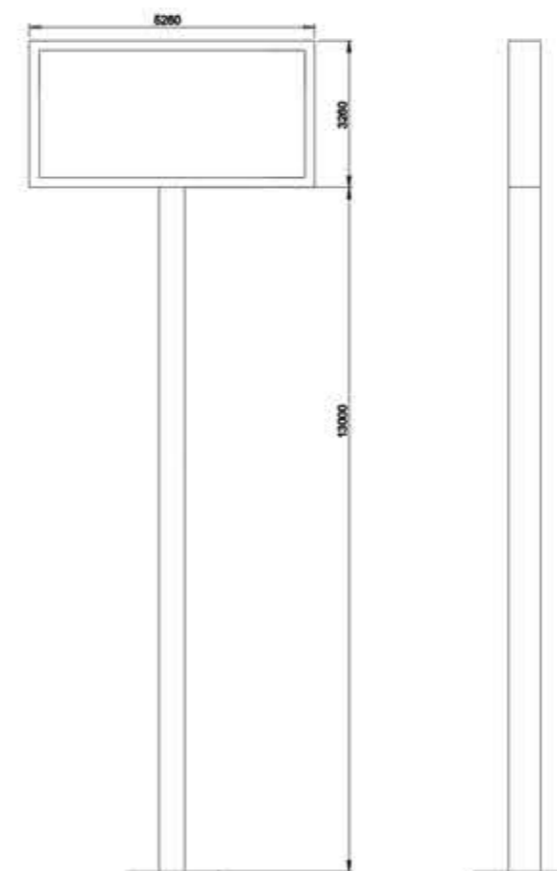

Feet Totem



Technical Specifications

Product Dimensions	3260mm X 5260mm X 13000mm
Main Material	Extruded Aluminum Profile + Steel Profile
Cladding	Cover, Extruded Aluminium Profile, Leg no cover
Ad Visible Area	3000mm X 5000mm
Lighting	Led
Coating	Electrostatic Powder Coating (RAL Catalogue)
Guarantee (Outdoor)	2 year

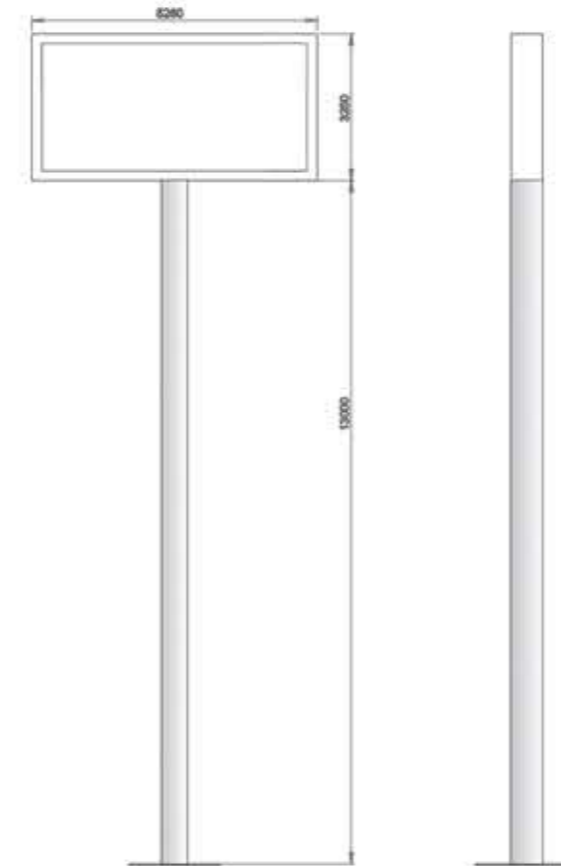

Bridge Billboard

Technical Specifications

Height	3000mm
Wide	10204mm
Main Material	Steel Profile
Poster Field	8 mm Plywood
Ad Visible Area	9700mm X 2500mm
Lighting	Projector Lighting
Scroller	Optional- Maximum 3 Poster
Coating	Electrostatic Powder Coating (RAL Catalogue)
Galvanize	Hot Dip Galvanized
Guarantee (Outdoor)	Metal 2 year, Plywood 5 Year

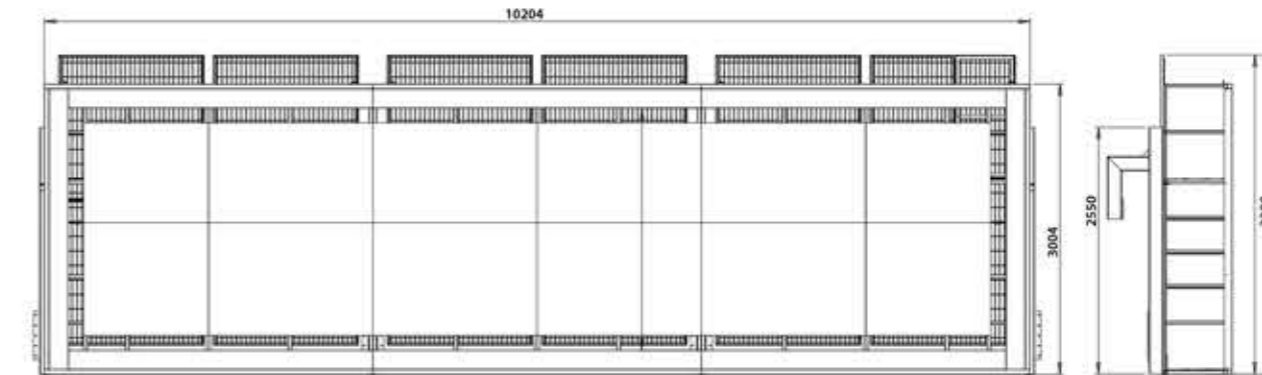

Silindir Kule

Technical Specifications



Product Dimensions	2540mm X \varnothing 1960mm
Main Material	Steel Profile + Extruded Aluminum Profile
Ad Visible Area	1700mm X 1130mm
Lighting	Flourescent
Coating	Electrostatic Powder Coating (RAL Catalogue)
Galvanize	Iron Meterial Hot Dip Galvanized
Guarantee (Outdoor)	2 year

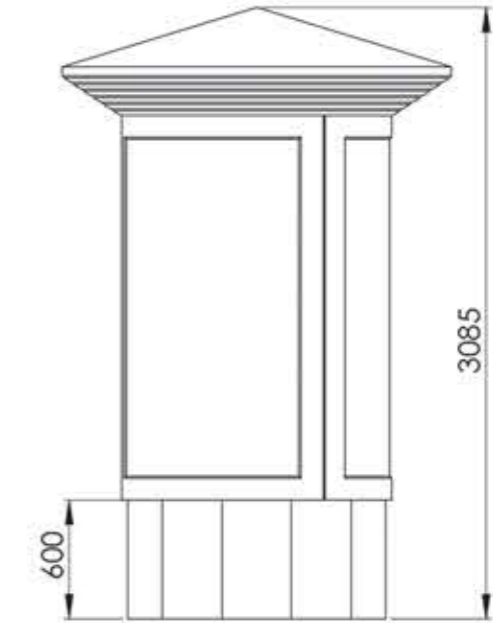
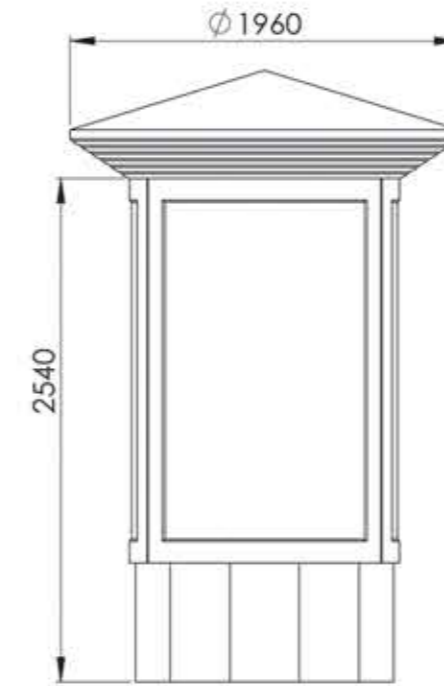

Pilon Totem



Technical Specifications

Height	2300 mm
Wide	546mm
Main Material	Steel Profile
Ad Visible Area	400 mm x 600 mm
Coating	Electrostatic Powder Coating (RAL Catalogue)
Galvanize	Iron Materias Hot Dip Galvanize
Guarentee (Outdoor)	Metal 2 Year

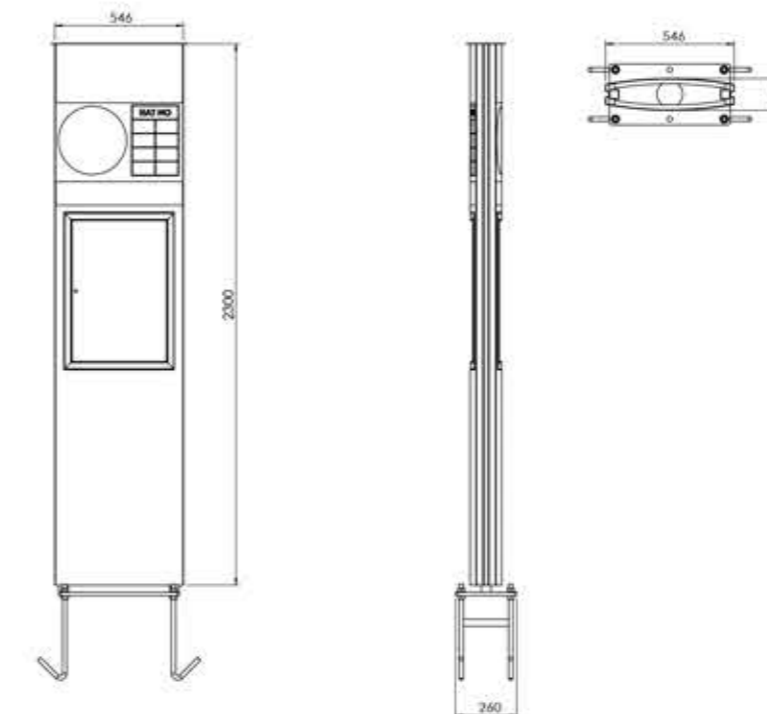

Qatar Wayfinding Signage

Technical Specifications



Height	Optional
Wide	Optional
Main Material	Steel Profile + Aluminium Cover
Coating	Electrostatic Powder Coating (RAL Catalogue)
Galvanize	Iron Materials Hot Dip Galvanize
Guarentee (Outdoor)	Metal 2 Year

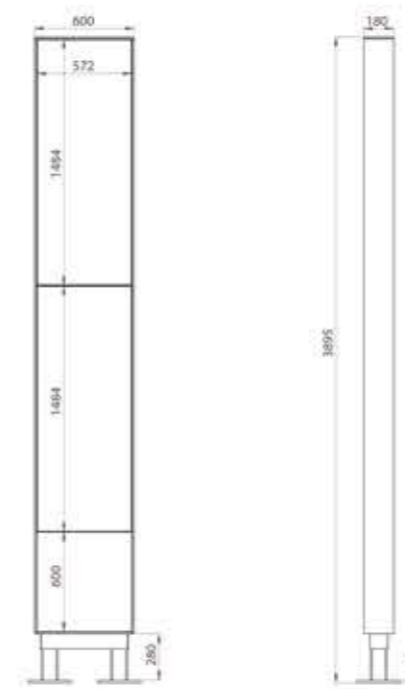

Qatar Wayfinding Signage

Technical Specifications



Height	Optional
Wide	Optional
Main Material	Steel Profil+ Aluminium Cover
Coating	Electrostatic Powder Coating (RAL Catalogue)
Galvanize	Iron Materials Hot Dip Galvanize
Guarentee (Outdoor)	Metal 2 Year

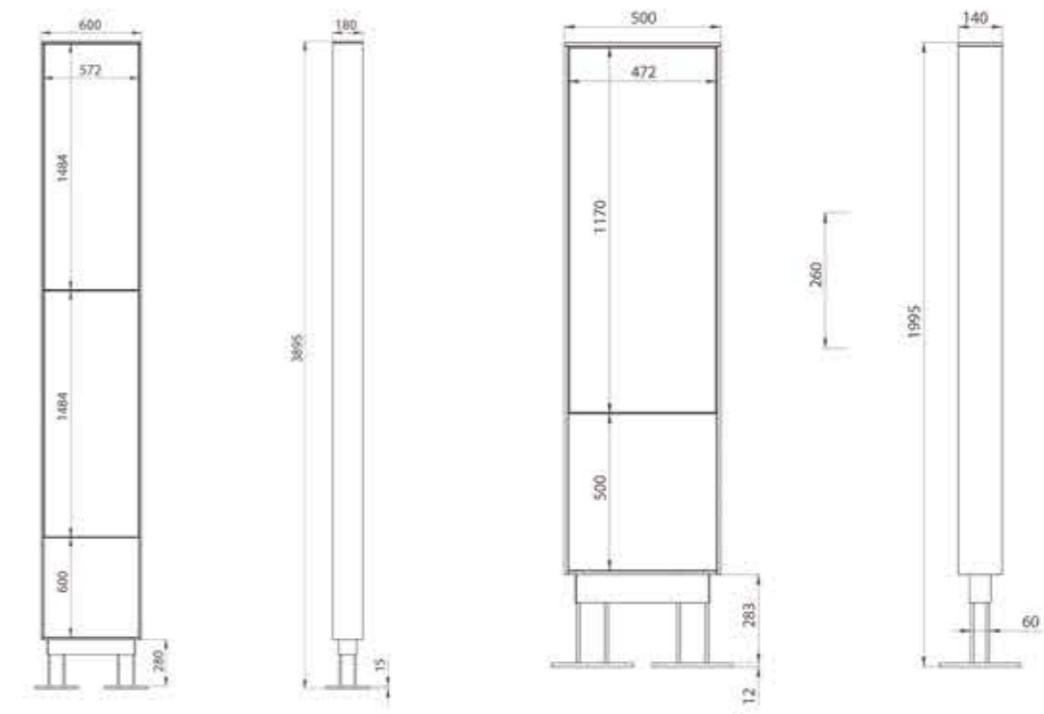

Buy Box Kiosk

Technical Specifications



Product Dimensions	1728 mm X 3212 mm X 4814 mm
Main Material	Extruded Aluminum Profile
Roof	Steel Construction+ Aluminium Extrude Profile+ Polyester Coating
Ad Visible Area	1705mm X 1155mm
Scroller	Optional- Maximum 3 Ad
Lighting	Backlit Fluorescent
Coating	Electrostatic Powder Coating (RAL Katalog)
Galvanize	Iron Materials Hot Dip Galvanized
Guarantee (Outdoor)	2 Year

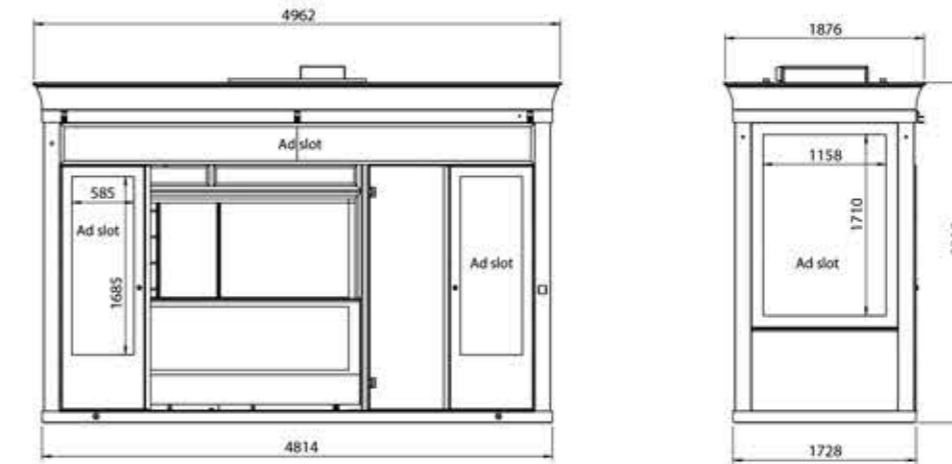

Stainles Kiosk



Technical Specifications

Product Dimensions	4130 mm X 3480 mm X 3000 mm
Main Material	Extruded Aluminum Profile
Back Field	8mm Tempered Glass
Roof	812 mm Laminated Glass
Ad Visible Area	1705mm X 1155mm
Scroller	Optional- Maximum 3 Ad
Lighting	Backlit Flourescent
Coating	Electrostatic Powder Coating (RAL Katalog)
Galvanize	Iron Materials Hot Dip Galvanized
Guarantee (Outdoor)	2 Year

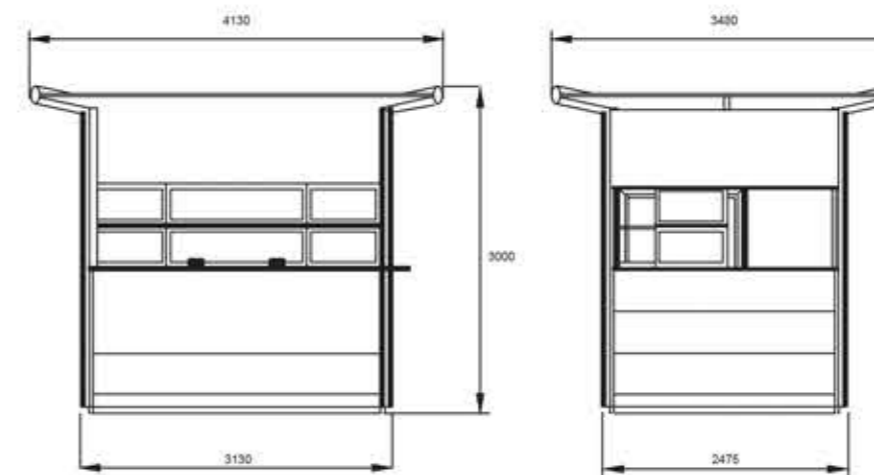

Magazine Kiosk

Technical Specifications



Product Dimensions	2475 mm X 3130 mm H:3000 mm
Main Material	Extruded Aluminum Profile
Back Field	8mm Tempered Glass
Roof	812 mm Laminated Glass
Ad Visible Area	1705mm X 1155mm
Scroller	Optional- Maximum 3 Ad
Lighting	Backlit Fluorescent
Coating	Electrostatic Powder Coating (RAL Katalog)
Galvanize	Iron Materials Hot Dip Galvanized
Guarantee (Outdoor)	2 Year

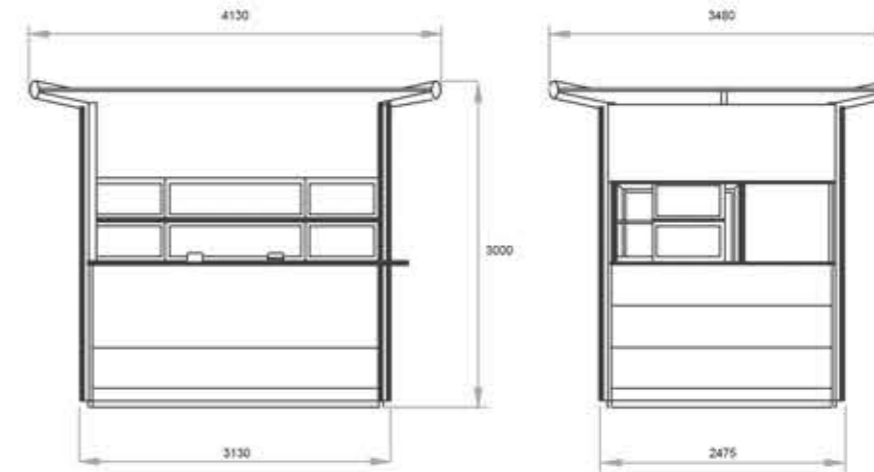

Ticket Kiosk



Technical Specifications

Product Dimensions	2680mm x3480mmx4130mm
Main Material	Extruded Aluminium Profile
All Sides	8 mm Tempered Glass
Roof	12mm Laminated Glass
Lighting	Flourescent
Coating	Electrostatic Powder Coating (RAL Catalogue)
Galvanize	Iron Materials Hot Dip Galvanized
Guarantee (Outdoor)	Metal 2 year,

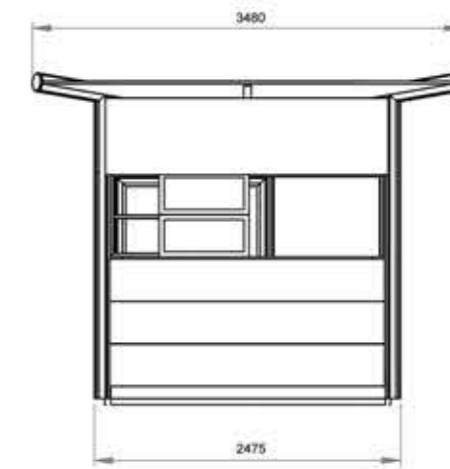
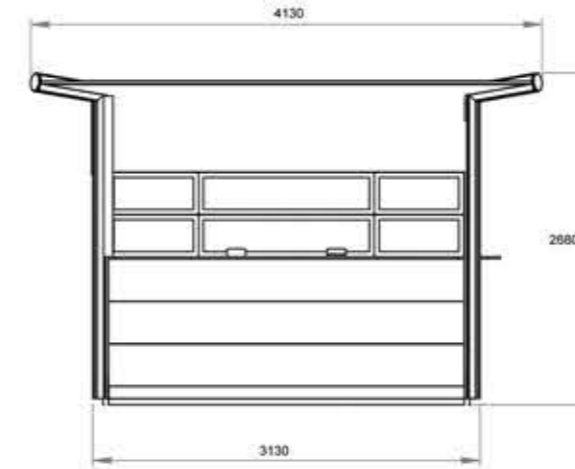

Vending Kiosk

Technical Specifications



Product Dimensions	4130mm X 3480mm X2680mm
Main Material	Extruded Aluminum Profile
All Sides	8mm Tempered Glass
Roof	12mm Laminated Glass
Lighting	Flourescent
Coating	Electrostatic Powder Coating (RAL Catalogue)
Galvanize	Iron Metarials Hot Dip Galvanized
Guarantee (Outdoor)	2 year

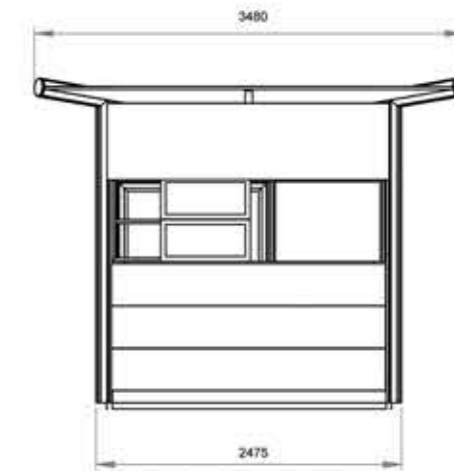
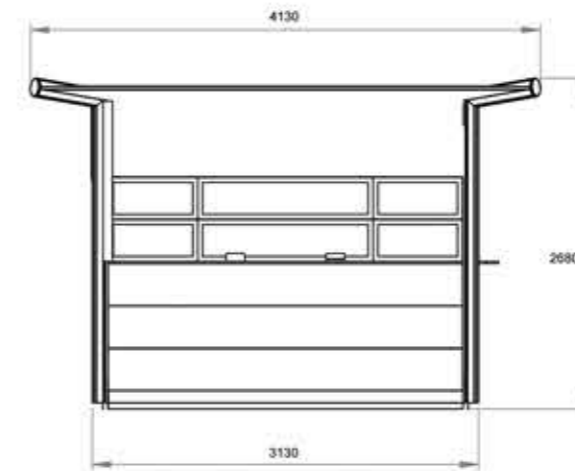



Product Dimensions	2800mm X3555 mm X 5500 mm
Main Material	Steel Construction+ Aluminium Cotating
Roof	Steel Construction+ Aluminium Cotating
Coating	Electrostatic Powder Coating (RAL Katalog)
Galvanize	Iron Materials Hot Dip Galvanized
Guarantee (Outdoor)	2 Year

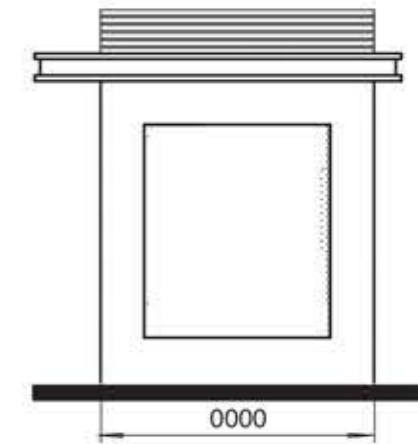
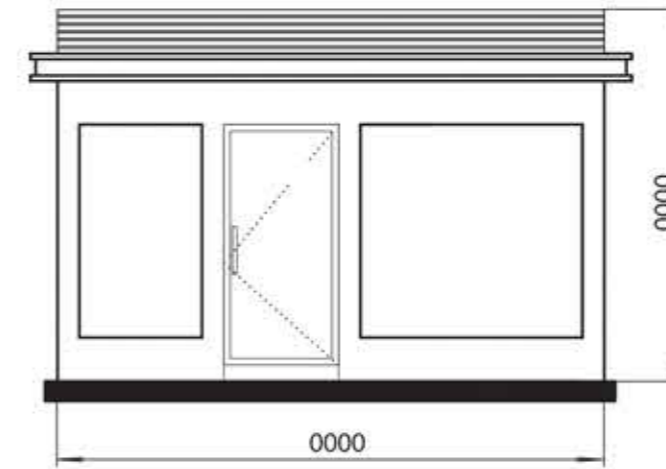

Taksi durağı Kiosk



Technical Specifications

Product Dimensions	2650 mm X 2700 mm X 7250 mm
Main Material	Steel Construction+ Aluminium Cotating
Roof	Steel Construction+ Aluminium Cotating
Coating	Electrostatic Powder Coating (RAL Katalog)
Galvanize	Iron Materials Hot Dip Galvanized
Guarantee (Outdoor)	2 Year

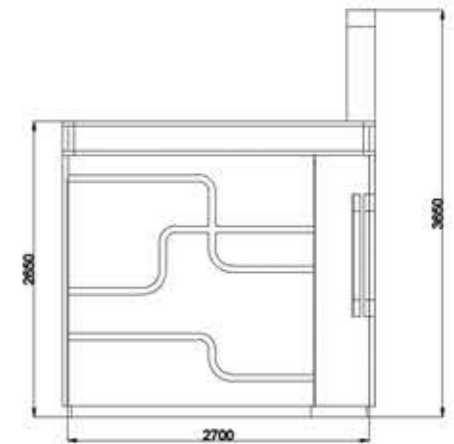
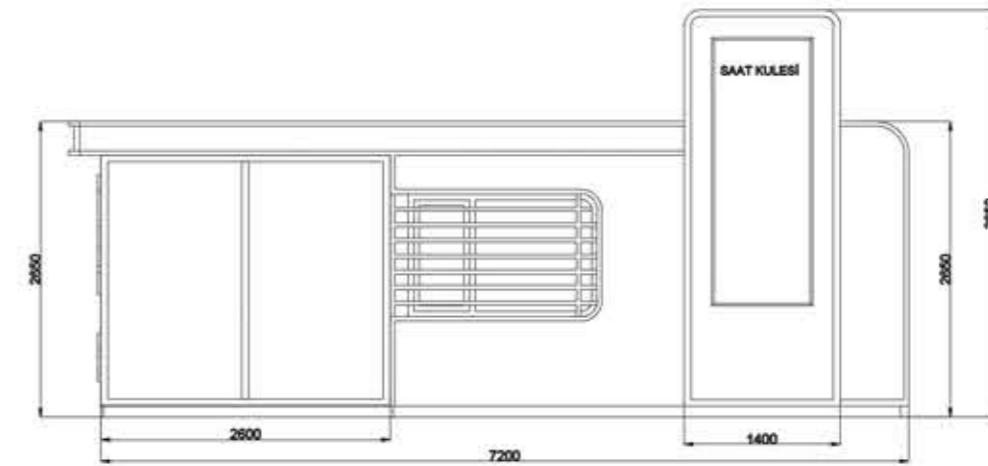

Baby Breastfeeding Cabinet

Technical Specifications



Product Dimensions	2000mm X3000 mm X 3050 mm
Main Material	Steel Construction+ Aluminium Cotating
Roof	Steel Construction+ Aluminium Cotating
Coating	Electrostatic Powder Coating (RAL Katalog)
Galvanize	Iron Materials Hot Dip Galvanized
Guarantee (Outdoor)	2 Year

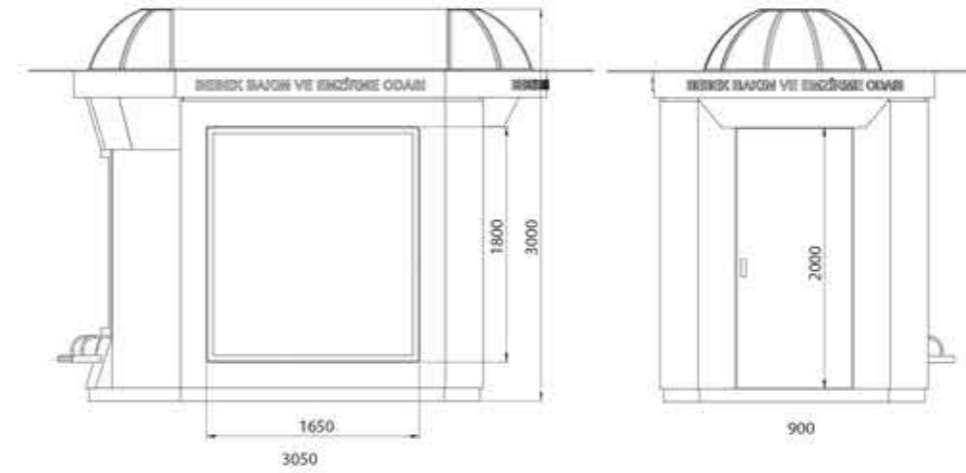



Product Dimensions	2020mmx2607mmx3612mm
Main Material	Steel Profile
Sides	8 mm Tempered Glass + Aluminum Cover
Lighting	Flourescent
Coating	Electrostatic Powder Coating (RAL Catalogue)
Galvanize	Iron Materials Hot Dip Galvanized
Guarantee (Outdoor)	Metal 2 year

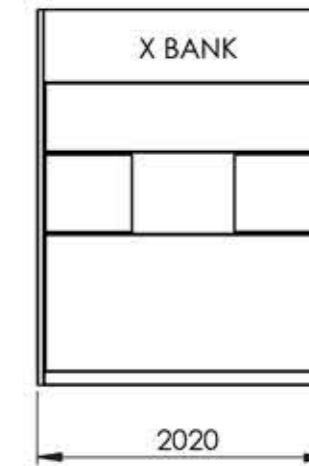
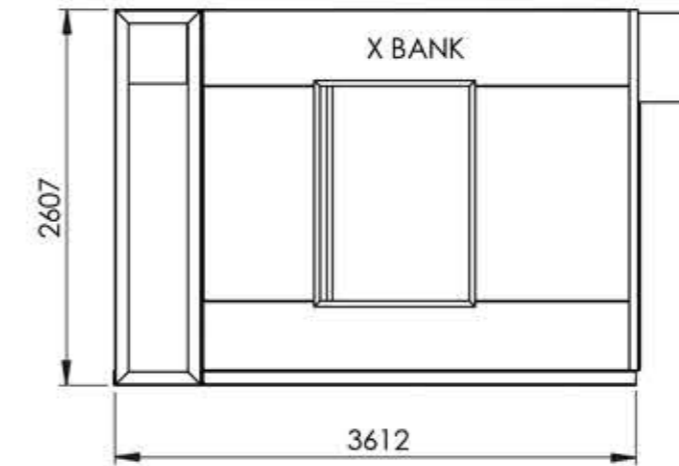

ATM Wall



Technical Specifications

Product Dimensions	2020mmx2607mmx3612mm
Main Material	Steel Profile
Sides	8 mm Tempered Glass + Aluminum Cover
Lighting	Flourescent
Coating	Electrostatic Powder Coating (RAL Catalogue)
Galvanize	Iron Materials Hot Dip Galvanized
Guarantee (Outdoor)	Metal 2 year

